

TRAMA 80

—By Alegre Design—

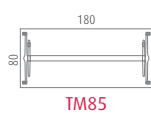

RECTANGULAR DESK 80 cm. WIDTH:

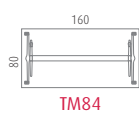
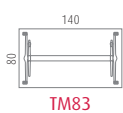

MEETING TABLES:

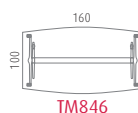

RECTANGULAR DESK 67 cm. WIDTH:

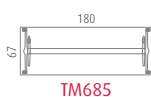
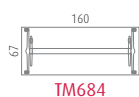
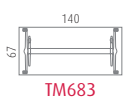

D-END TABLE

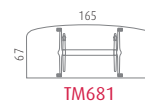
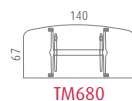

EXAMPLE LAYOUTS:

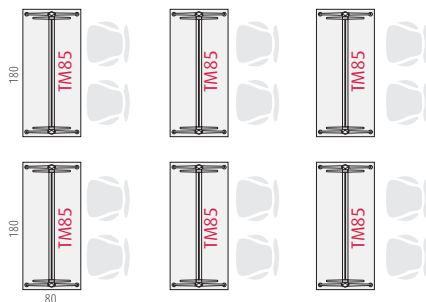
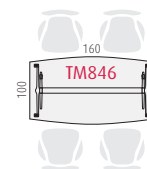
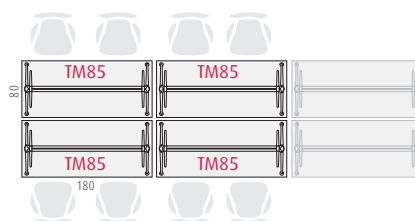
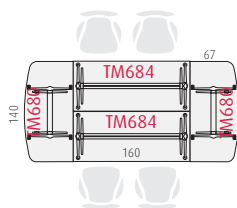

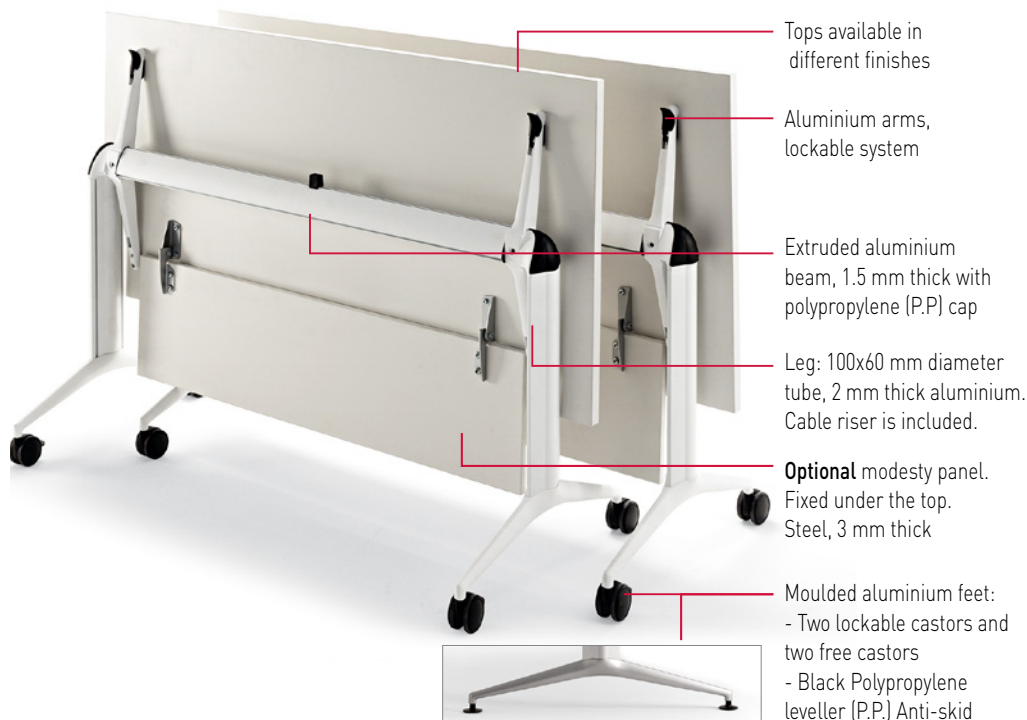

Tops available in different finishes

Aluminium arms, lockable system

Extruded aluminium beam, 1.5 mm thick with polypropylene (P.P) cap

Leg: 100x60 mm diameter tube, 2 mm thick aluminium. Cable riser is included.

Optional modesty panel. Fixed under the top. Steel, 3 mm thick

Moulded aluminium feet:
- Two lockable castors and two free castors
- Black Polypropylene leveller (P.P.) Anti-skid

■ FLIP TOP

Easy Flip top system for a comfortable and functional

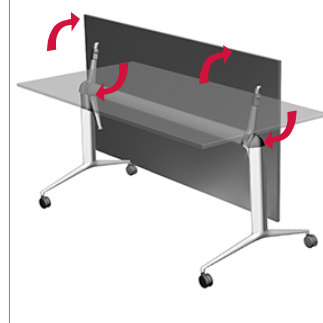

■ FRAME



- ① **Arms:** Moulded aluminium arms available in silver, white and black.
- ② **Beam:** Extruded aluminium profile, curved triangular shape 1.5 mm thick with polypropylene (P.P) cap, shaped with epoxy cover. Available in silver, white or black.
- ③ **Linking devices:** Moulded aluminium with epoxy cover. Available in silver, white or polished. Black plastic trim. Black polypropylene (P.P) trim.
- ④ **Leg:** 100x60 mm diameter tube, 2 mm thick extruded aluminium. Available in silver, white and black.
- ⑤ **Feet:** Moulded aluminium foot available in silver, white and polished. Two different sizes:
- 72 cm for desks 80 cm and 100 cm width.
- 55 cm for desks 67cm width.
- ⑥ **Two options:**
- **Castors:** Black anti-skid castors 65 mm diameter. 2 lockable castors and 2 free castors.
- **Levellers:** Black Polypropylene leveler (P.P.) Anti-skid

■ FRAME FINISHES



Silver frame

Arm: Silver
Beam: Silver
Linking device: Silver
Trim: Black
Leg: Silver
Foot: Silver
Castor: 65 mm. Black
Leveller: Black



White frame

Arm: White
Beam: White
Linking device: White
Trim: Black
Leg: White
Foot: White
Castor: 65 mm.
Black Leveller: Black



Black frame

Arm: Black
Beam: Black
Linking device: Polished
Trim: Black
Leg: Black
Foot: Polished
Castor: 65 mm. Black
Leveller: Black

■ DESK TOP FINISHES

Melamine (25 mm)



White



Maple



Elm



Chestnut

(See finishes cards)

■ LINKING DEVICE SYSTEM



Quick desk linking device. Desks are ready to be linked side to side. Linking device 4 mm thickness



MATERIALS

Maximum use of materials to eliminate and minimize scraps. Use of recyclable and recycled materials in those components that do not affect the functionality and durability.

77,07%
RECYCLED
MATERIALS



PRODUCTION

Maximum optimization of energy use. Minimal environmental impact. Last generation technological systems. Zero discharge of wastewater. No VOC coatings. Processes free of heavy metals, phosphates, OC and COD.

100%
RECYCLABLE
ALUMINIUM, STEEL
& WOOD



TRANSPORT

Detachable systems. Volumes that facilitate the optimization of space. Maximum reduction of energy consumption by transport.

100%
RECYCLABLE
PACKAGE AND THINNER
FREE



USE

Quality and warranty. Long lasting. Replacements available.

EASY
TO CLEAN
AND MAINTAIN



DISPOSAL

Waste reduction. Supplier-manufacturer packaging reuse system. Components are easy to be separated. Inks in packaging are water-based, without solvents.

91,52%
RECYCLABLE
MATERIALS

■ **CERTIFICATES AND REFERENCES**

The different programmes get points in different environmental categories to get the LEED certificate (sustainability, material and resources, water, energy and atmosphere, inner environment quality, innovation and design).



The mark of responsible forestry



PEFC Certificate



EN ISO 14006:2011
ECODESIGN Certificate



UNE-EN ISO 9001:2008
ISO 9001 Certificate



UNE-EN ISO 14001:2004
ISO 14001 Certificate



E1 Certificate
by EN 13986



PARQUE TECNOLÓGICO ACTIU
proyecto certificado LEED® GOLD
por el U.S. Green Building Council en 2011
Leadership in Energy & Environmental Design

■ **STANDARDS**

TRAMA has passed tests done in our technical department as well as the tests done in AIDIMA the Technological Institute for furniture. The tests correspond to UNE standards and office desks:

- **UNE: EN 527-1:2011.** Office Furniture. Desks. **Part 1:** Dimensions.
- **UNE: EN 527-2:2003.** Office Furniture. Desks. **Part 2:** Mechanical security requirements.
- **UNE: EN 527-3:2003.** Office Furniture. Desks. **Part 3:** Test to determine stability and structure resistance.
- **UNE: EN 15372:08.** Office Furniture. Strength, durability and safety. Requirements for domestic use desks. Office Furniture. Desks. **Part 2:** Strength, durability and safety.
- **UNE: EN 1730:13.** Furniture. Tables. Test methods for the determination of stability, strength and durability.
- **UNE: EN14073-2:05.** Office furniture. Tables and desks and storage furniture. Safety requirements.
- **UNE: EN 14073-3:05.** Office furniture. Tables and desks and storage furniture. Test methods for the determination of stability and strength of the structure.
- **UNE: EN 14074:05.** Office furniture. Tables and desks and storage furniture. Test methods for the determination of strength and durability of moving parts.