

Valero

LHV

F O R M L I N E R

COLLECTION

WOOD • FORM • STONE

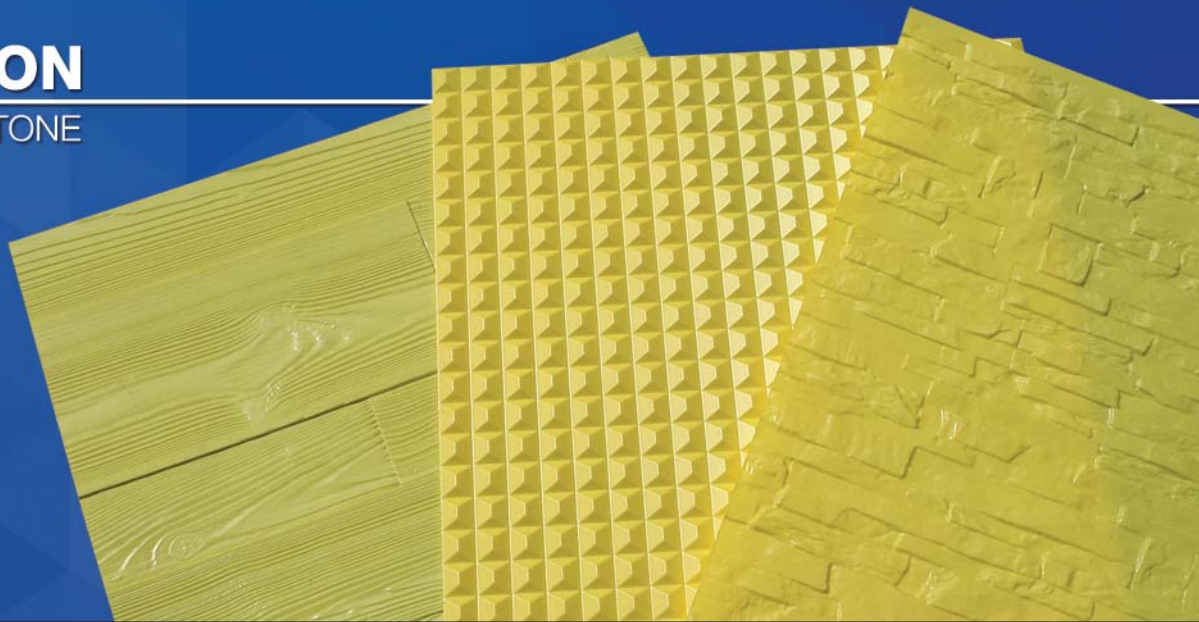

www.lhvformliner.com

Valero

LHV

F O R M L I N E R

Pruébalo y supérate
con nosotros.

EN.Try it and better yourself with us. **FR.**Essayez-le et améliorez-vous avec nous **DE.**Probieren Sie es aus und wachsen Sie mit uns über sich hinaus.



Para todo tipo de obra

Valero **LHV Formliner** son unas láminas plásticas capaces de dotar al hormigón de cualquier textura o relieve deseado por el cliente. Son ligeras, fáciles de aplicar, y compatibles con todos los sistemas de encofrado existentes en el mercado, tanto verticales como horizontales.

EN

For every kind of construction.

Valero **LHV Formliners** are sheets that have the ability to give concrete any texture or relief desired by the client. They are light, easy to install and compatible with all formwork systems on the market, both vertical and horizontal.

FR

Pour tout type d'ouvrage.

Les **LHV Formliners** Valero sont des lamelles capables de doter le béton de toute sorte de texture ou de relief désirés par le client. Elles sont légères, faciles à appliquer, et compatibles avec tous les systèmes de coffrage qui existent sur le marché, qu'ils soient verticaux ou horizontaux.

DE

Für alle Arbeitsarten auf der Baustelle.

Die Valero **LHV Formliner** sind Bahnen, die den Beton mit unterschiedlichen Oberflächenstrukturen und Reliefs versehen, je nach Belieben des Verbrauchers. Sie sind leicht, einfach anzubringen und mit allen auf dem Markt erhältlichen Schalungssystemen kompatibel, seien es vertikale oder horizontale Schalungssysteme.



Nunca fue mejor momento
ni nadie lo puso **tan fácil**
para **diferenciarse**
del resto.

EN.Never was better moment and nobody did it so easy to be different from the rest. **FR.**C'est le meilleur moment pour vous différencier du reste, et jamais personne ne vous avait autant aidé à y parvenir. **DE.**Nie war es ein besseres Moment und nie war es leichter, sich vom Rest zu unterscheiden.



Acabado en hormigón. / EN.Concrete finish. / FR.Finition béton. / DE.Betonbau.



Acabado final en barniz. / EN.Final finish with varnish. / FR.Finition vernis. / DE.Betonbau mit Lackanstrich.







WOOD COLLECTION

MOD.

001

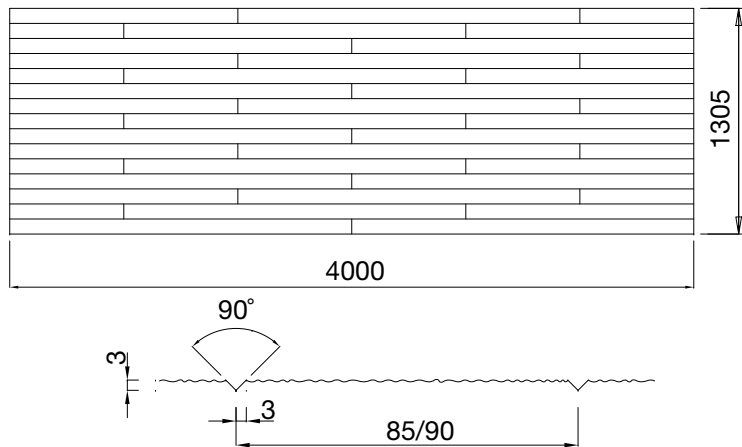

MOD.
002

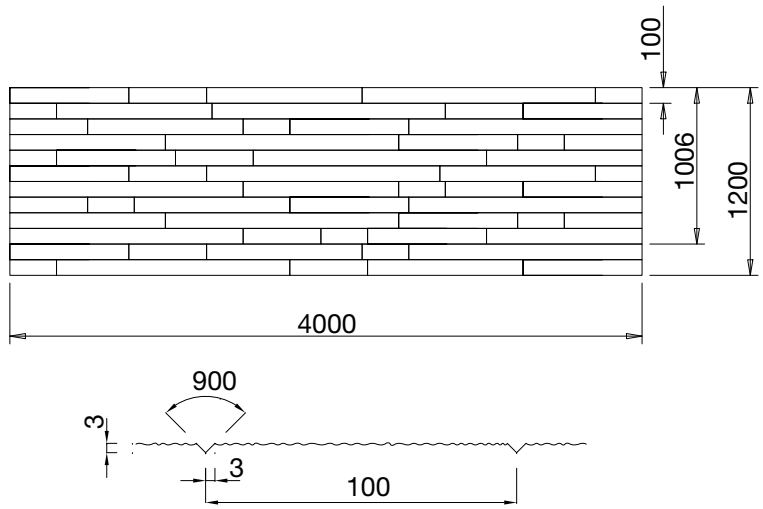
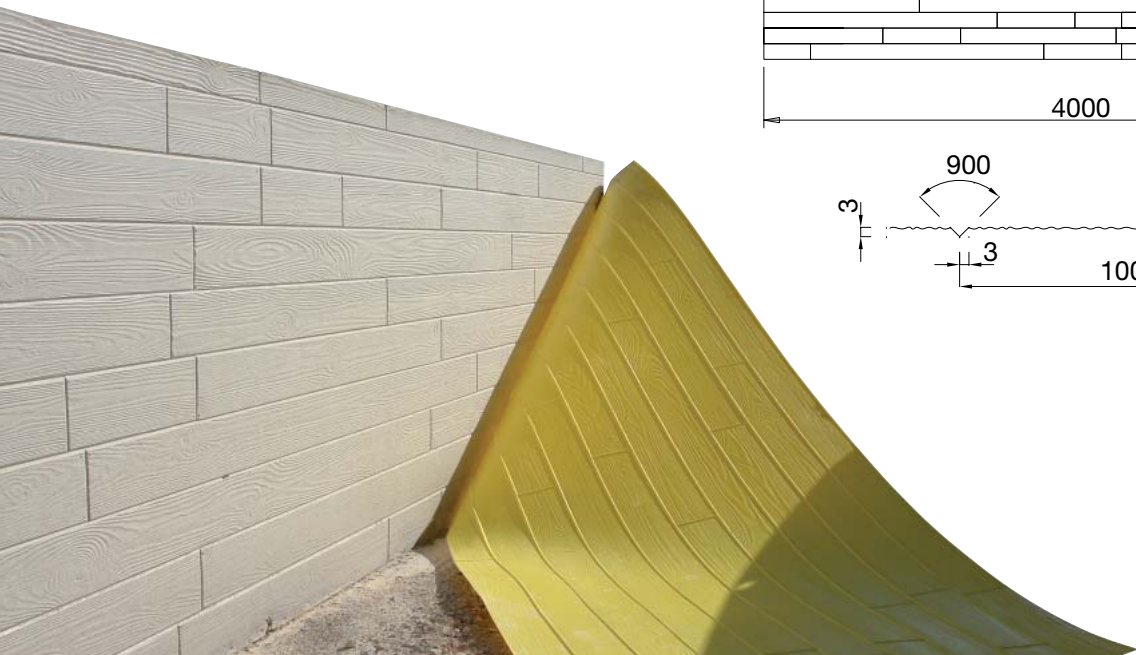

WOOD COLLECTION

MOD.

003

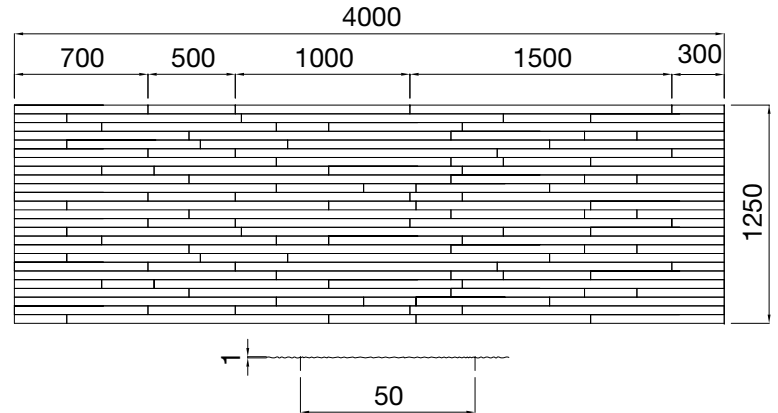
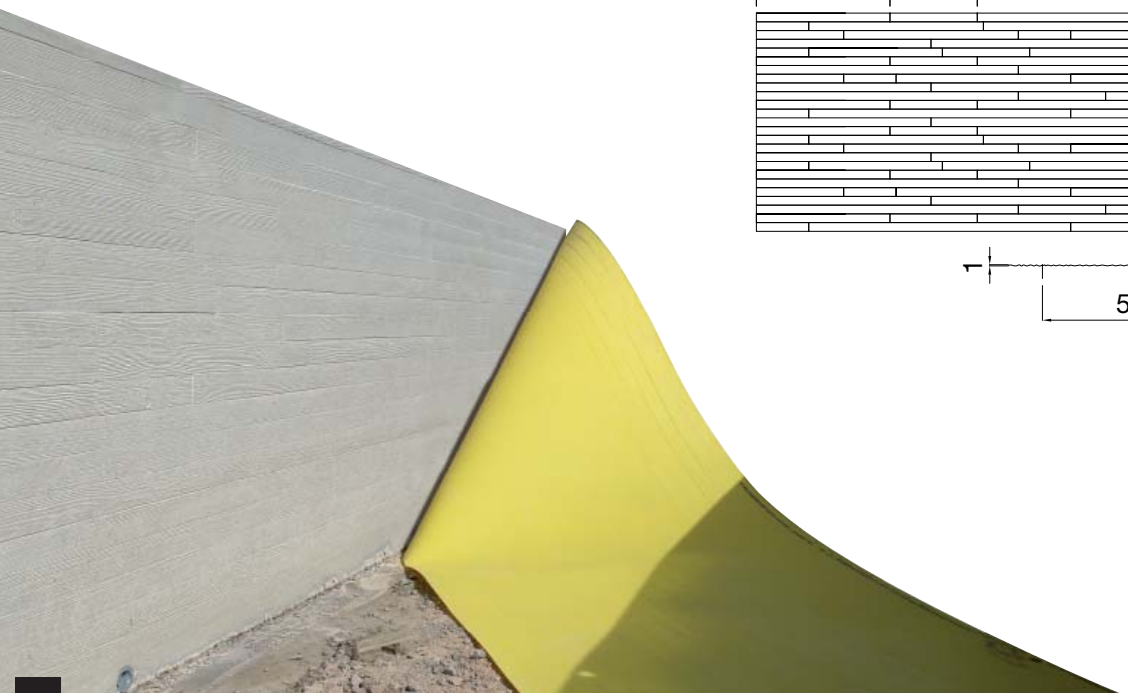

MOD.
004

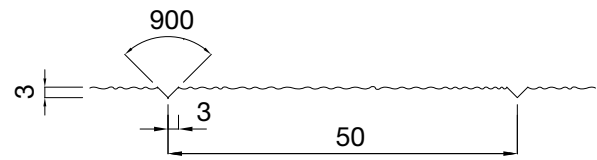
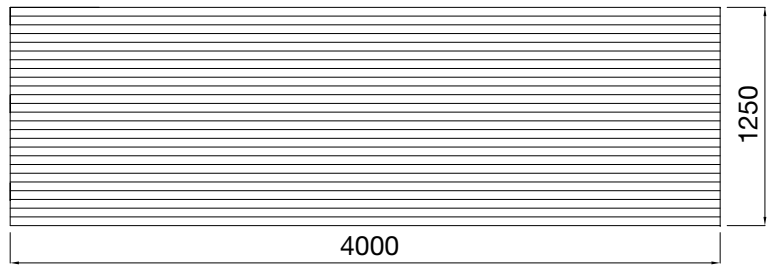
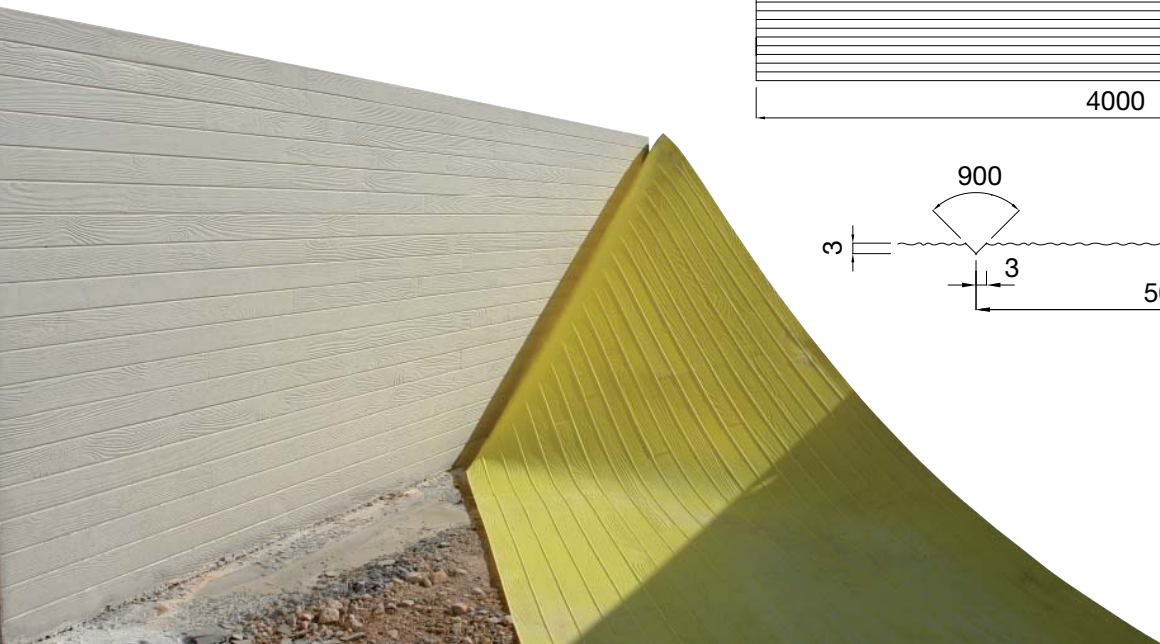

WOOD COLLECTION

MOD.

005

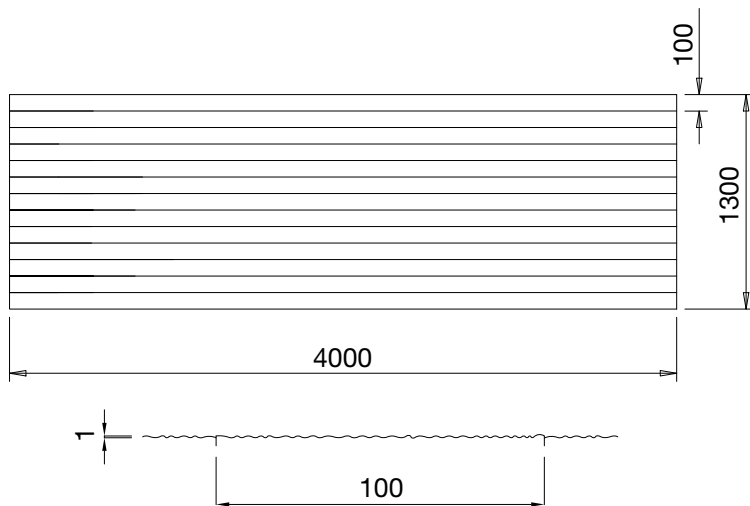

MOD.
006

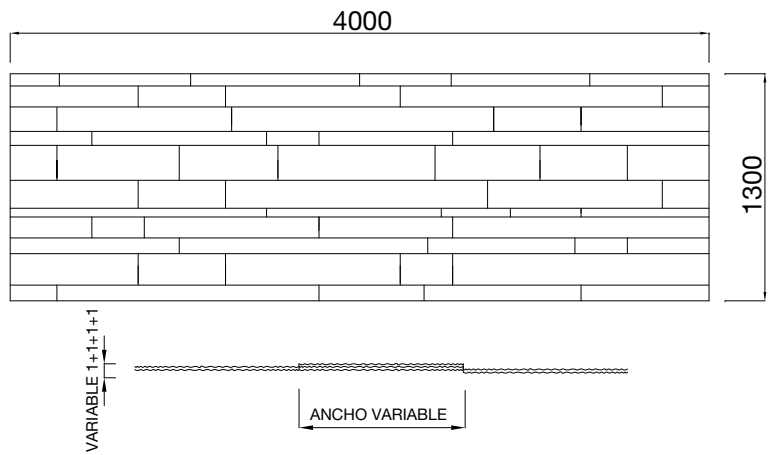

WOOD COLLECTION

MOD.

007

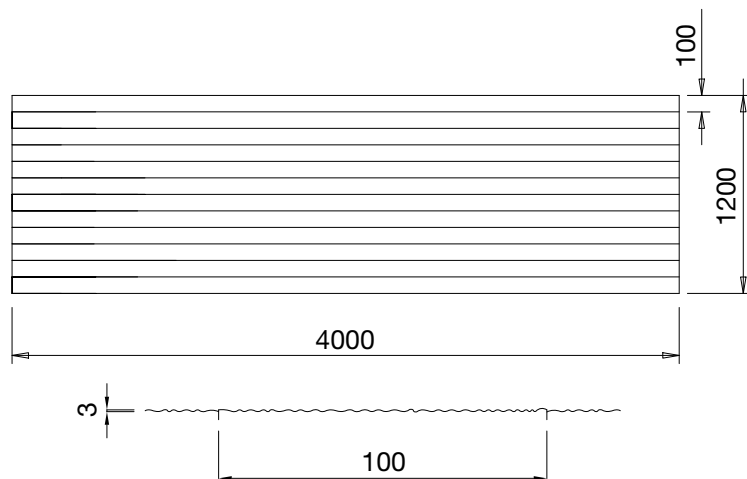

MOD.
008

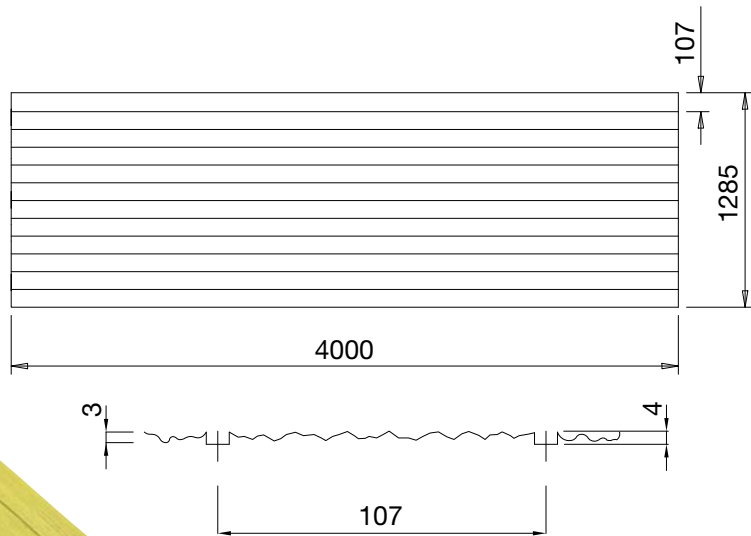
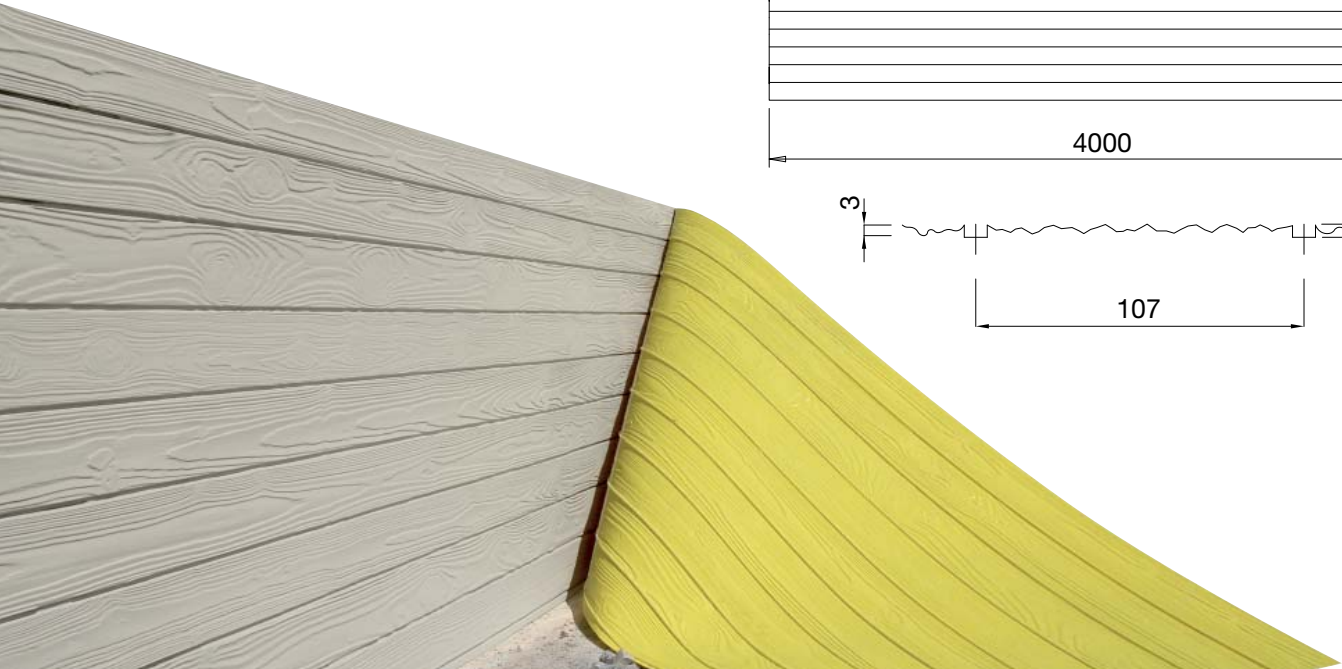

WOOD COLLECTION

MOD.

009

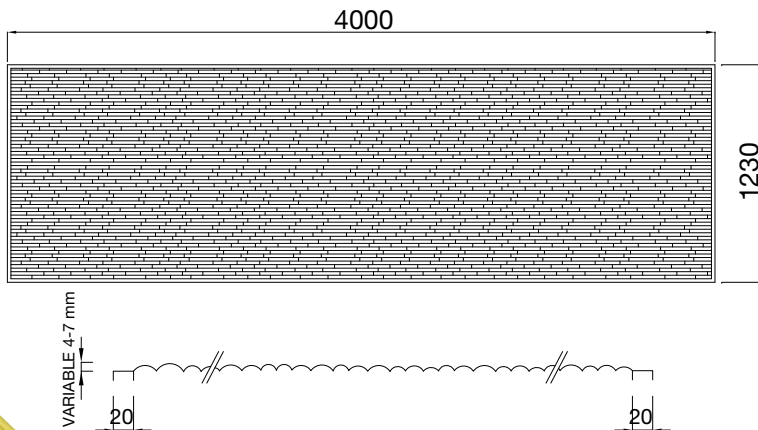
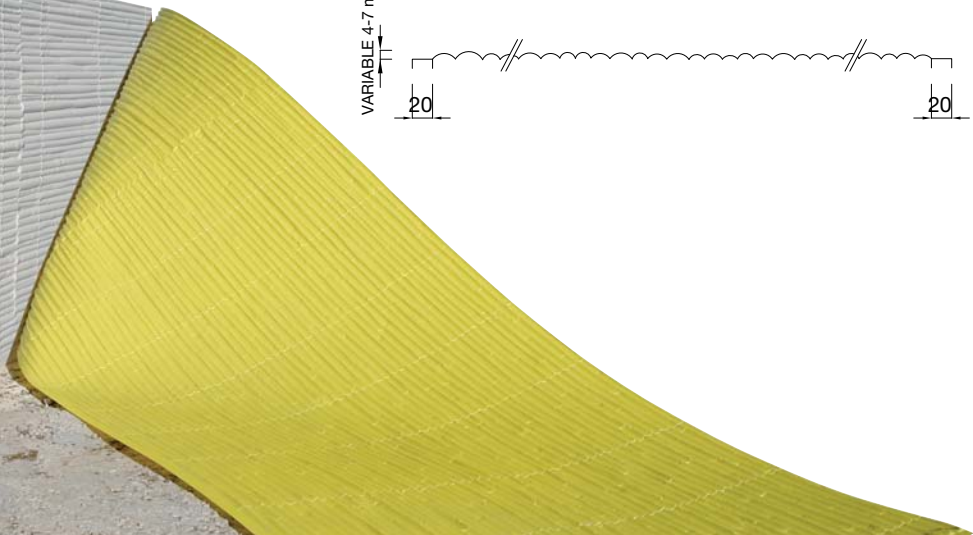

MOD.
010

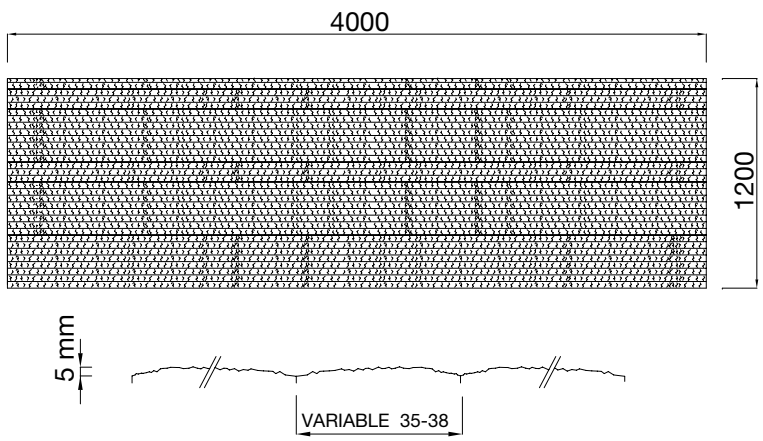
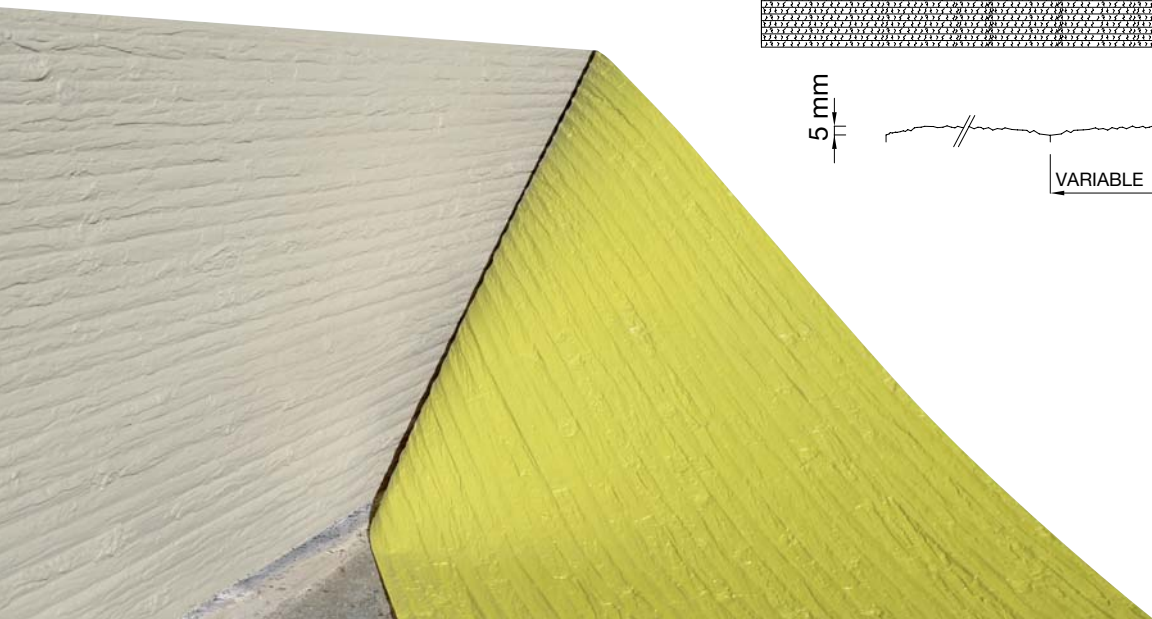

WOOD COLLECTION

MOD.

011

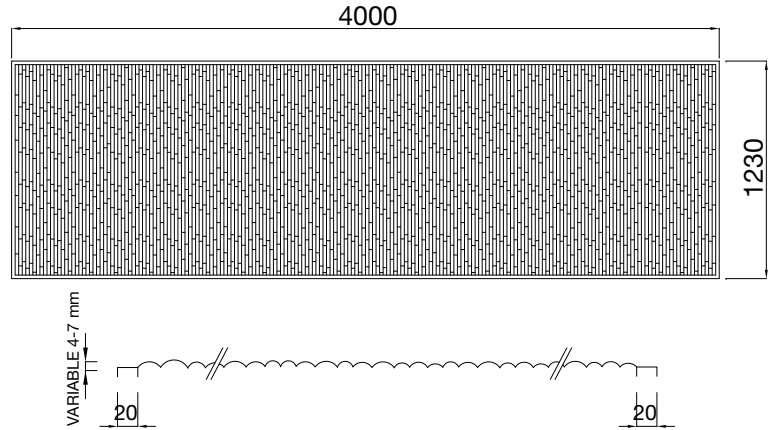
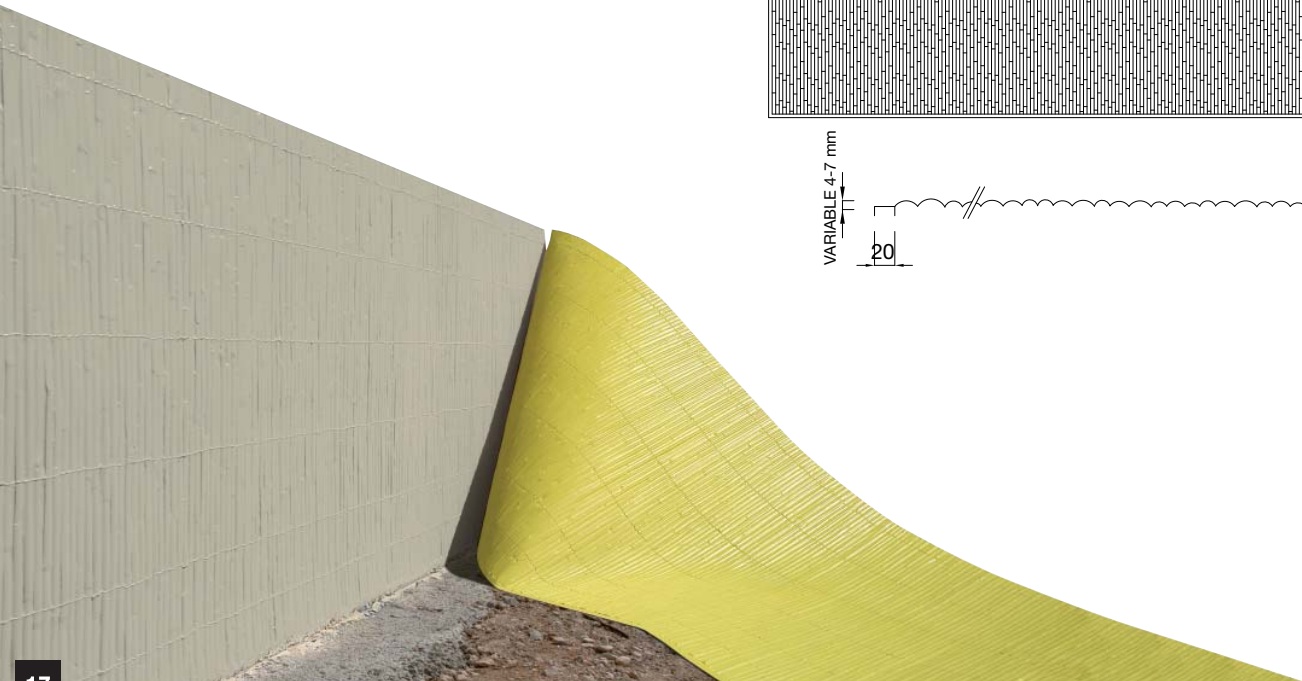

MOD.
012

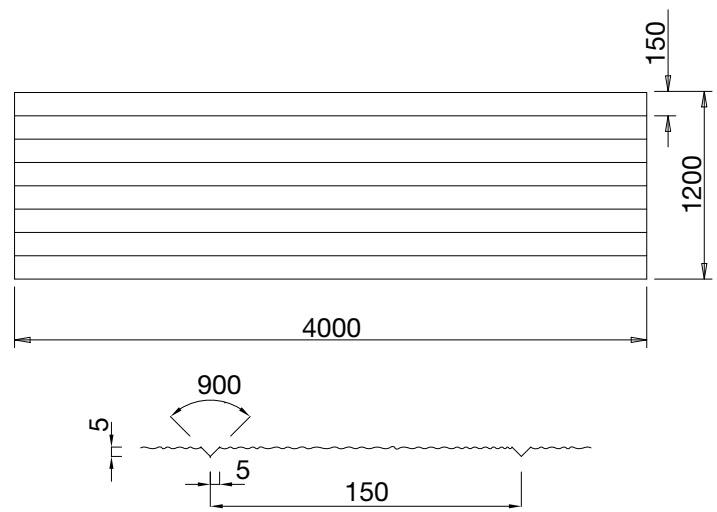
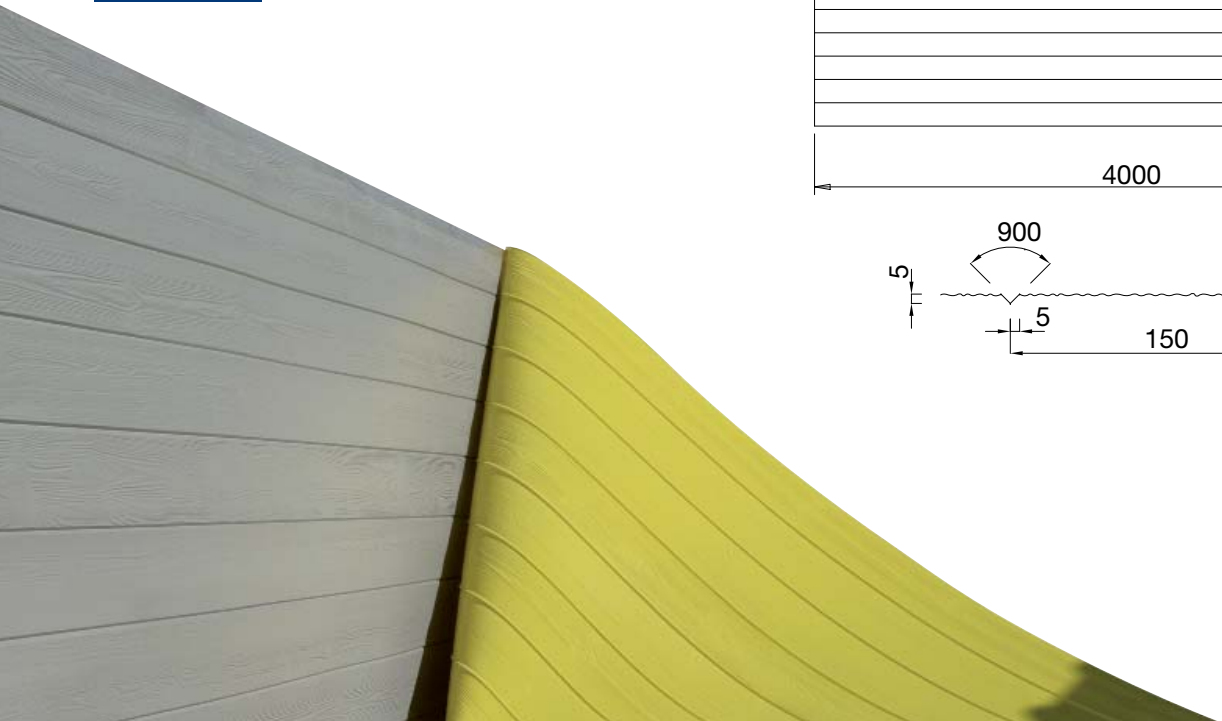

WOOD COLLECTION

MOD.

013

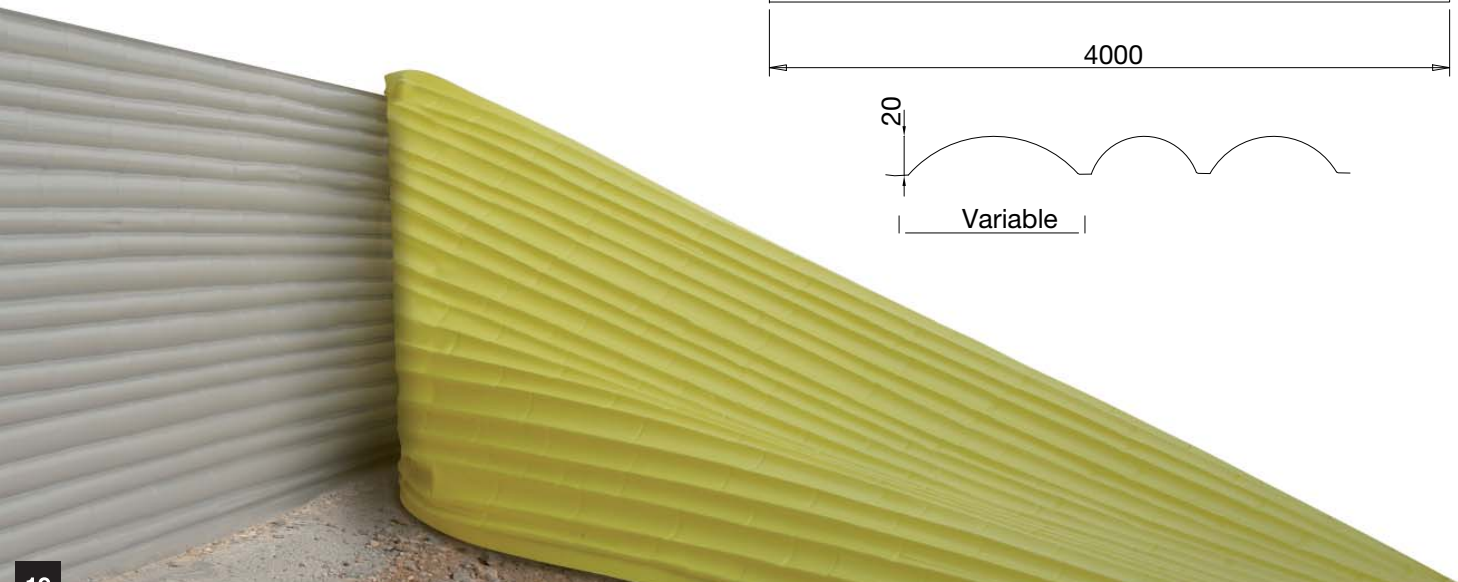
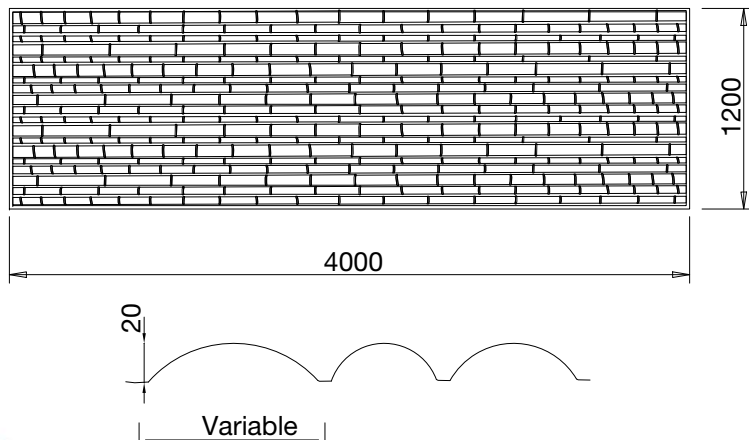

MOD.

074

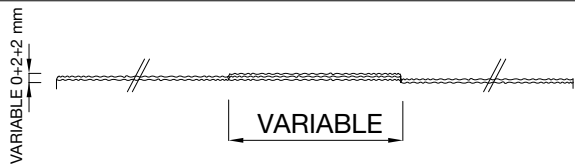
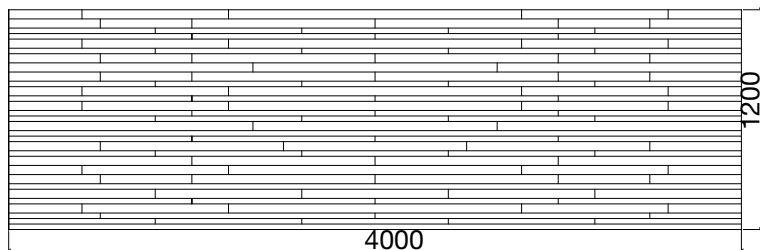



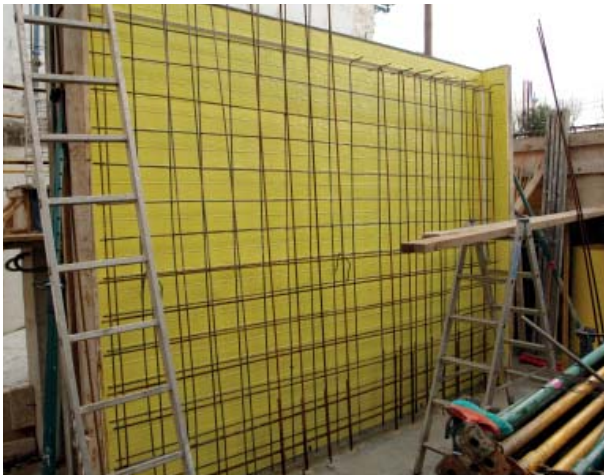

FORM COLLECTION

MOD.

021

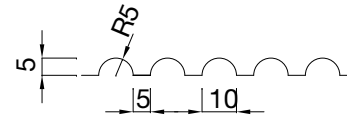
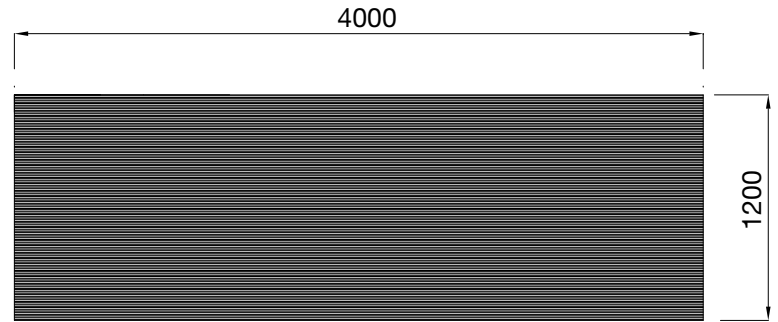
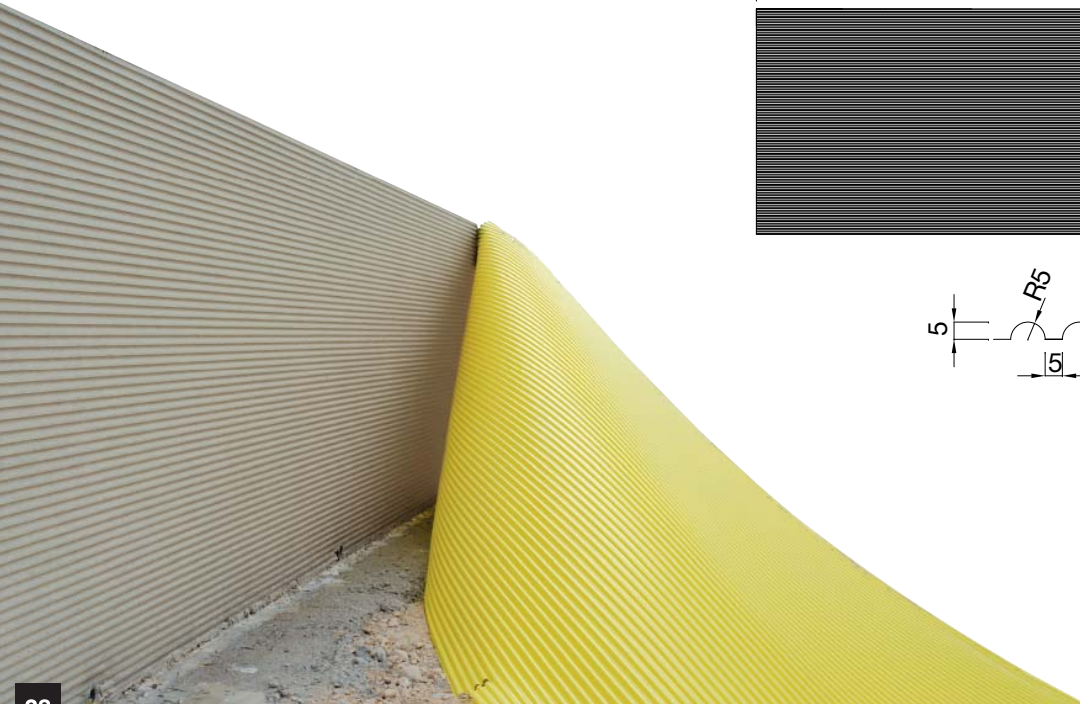

MOD.
023

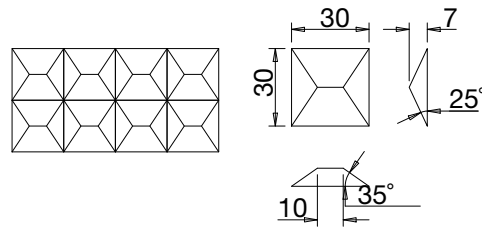
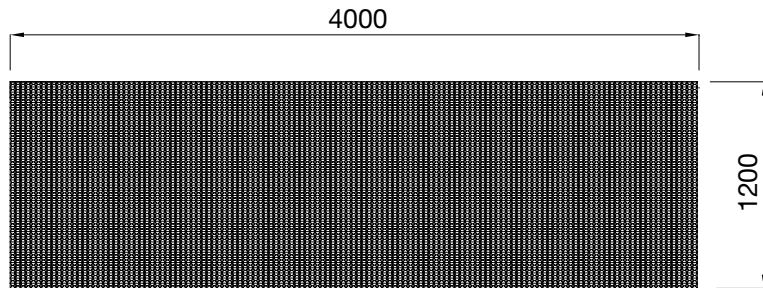
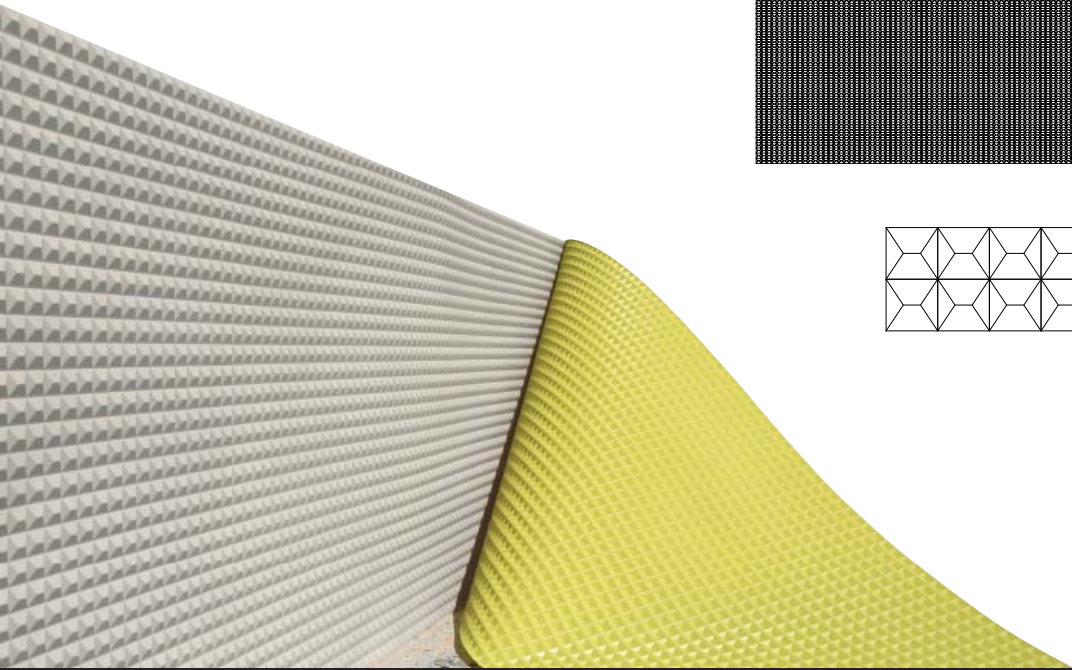

FORM COLLECTION

MOD.

024

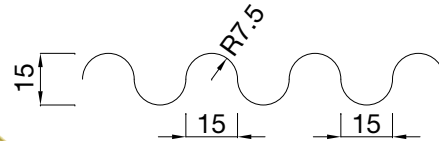
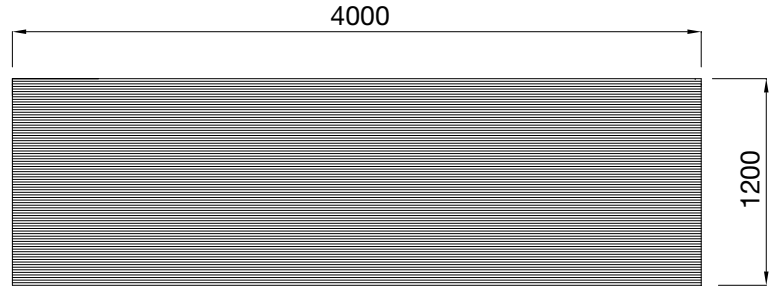

MOD.
025

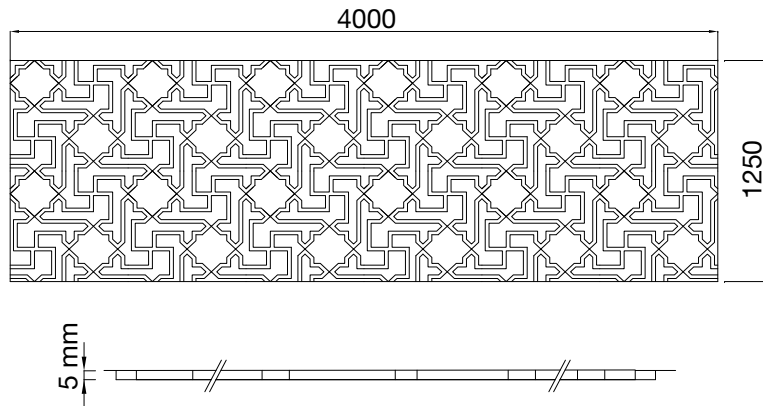

FORM COLLECTION

MOD.

026

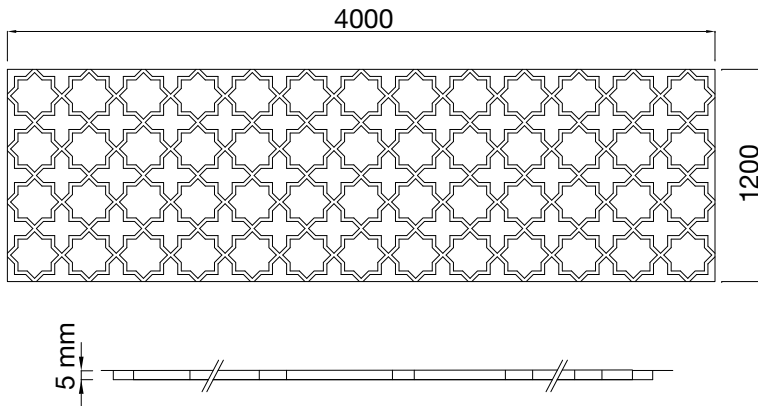
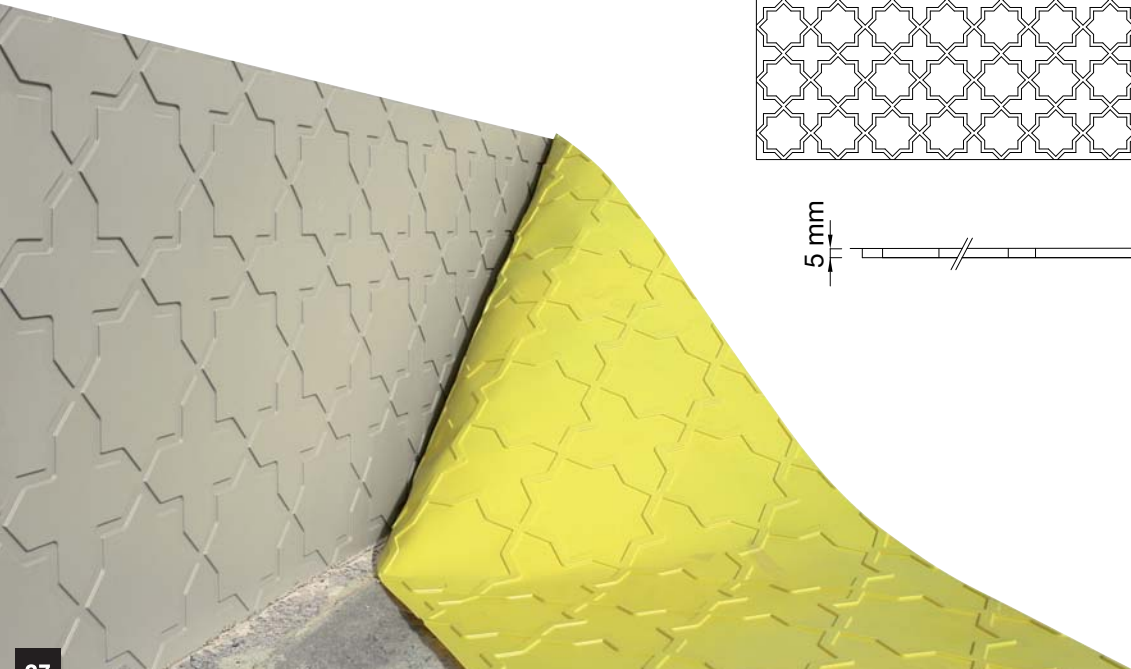

MOD.

027

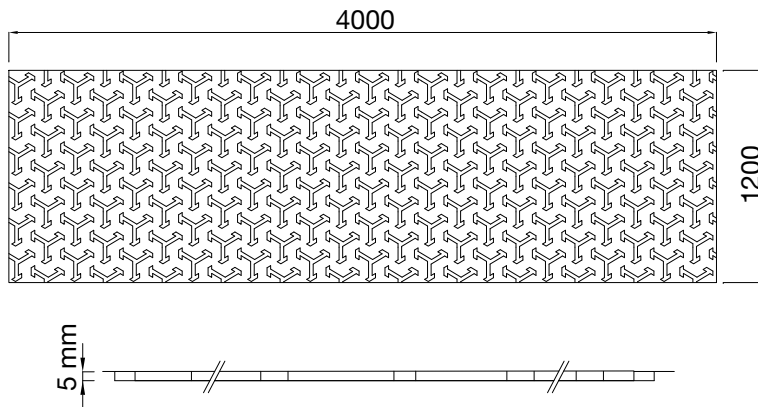
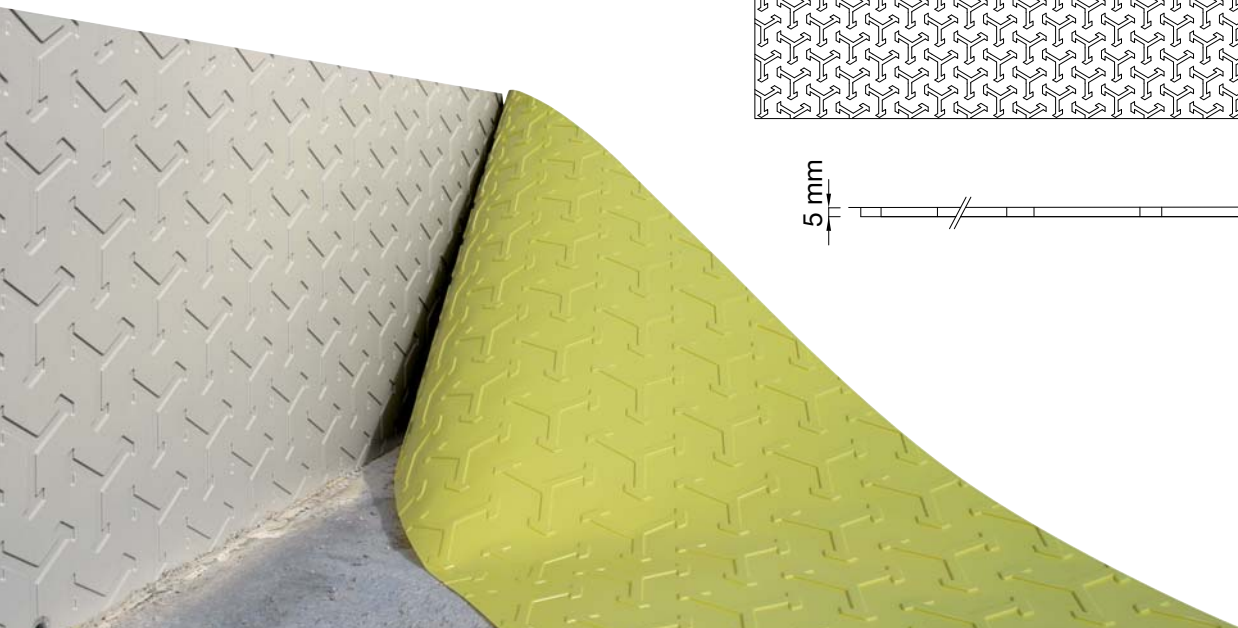

FORM COLLECTION

MOD.

028

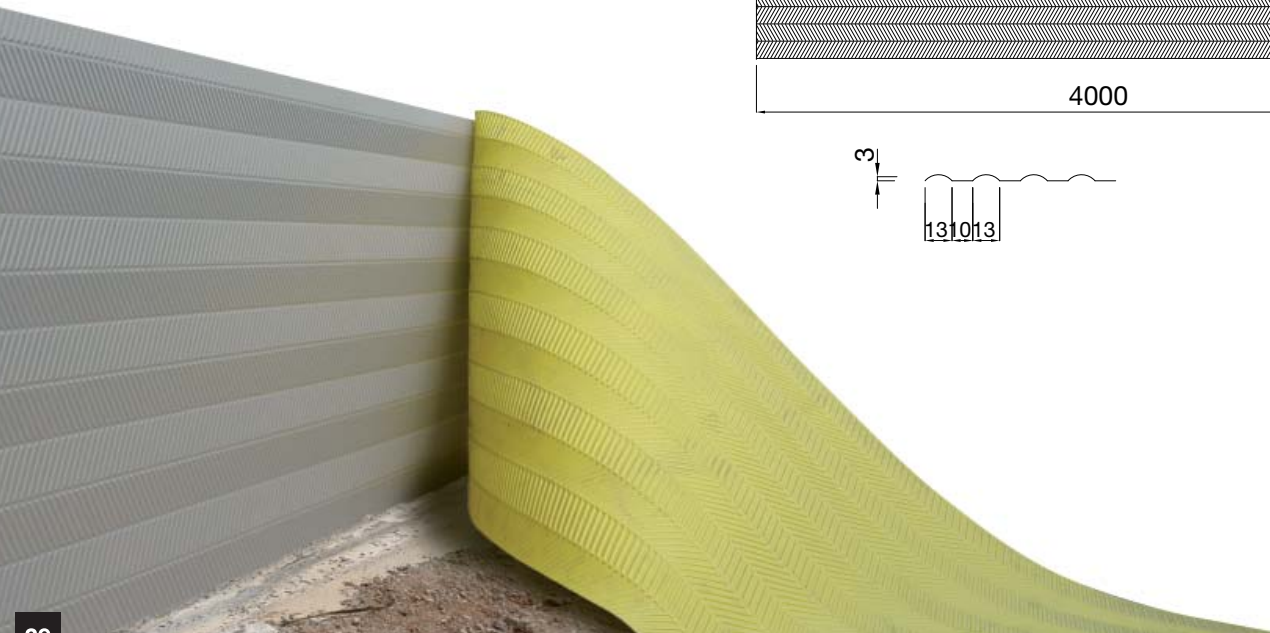
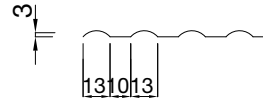
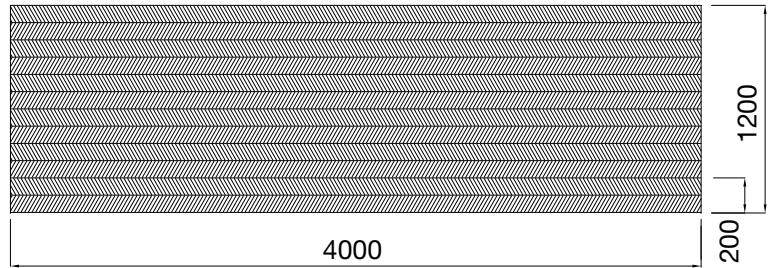

MOD.

029

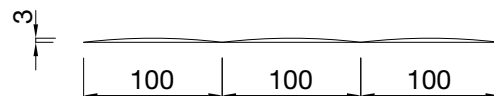
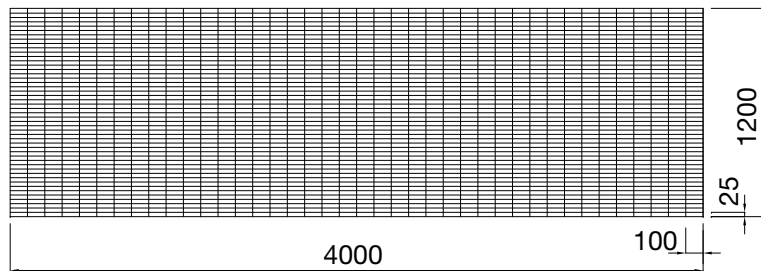
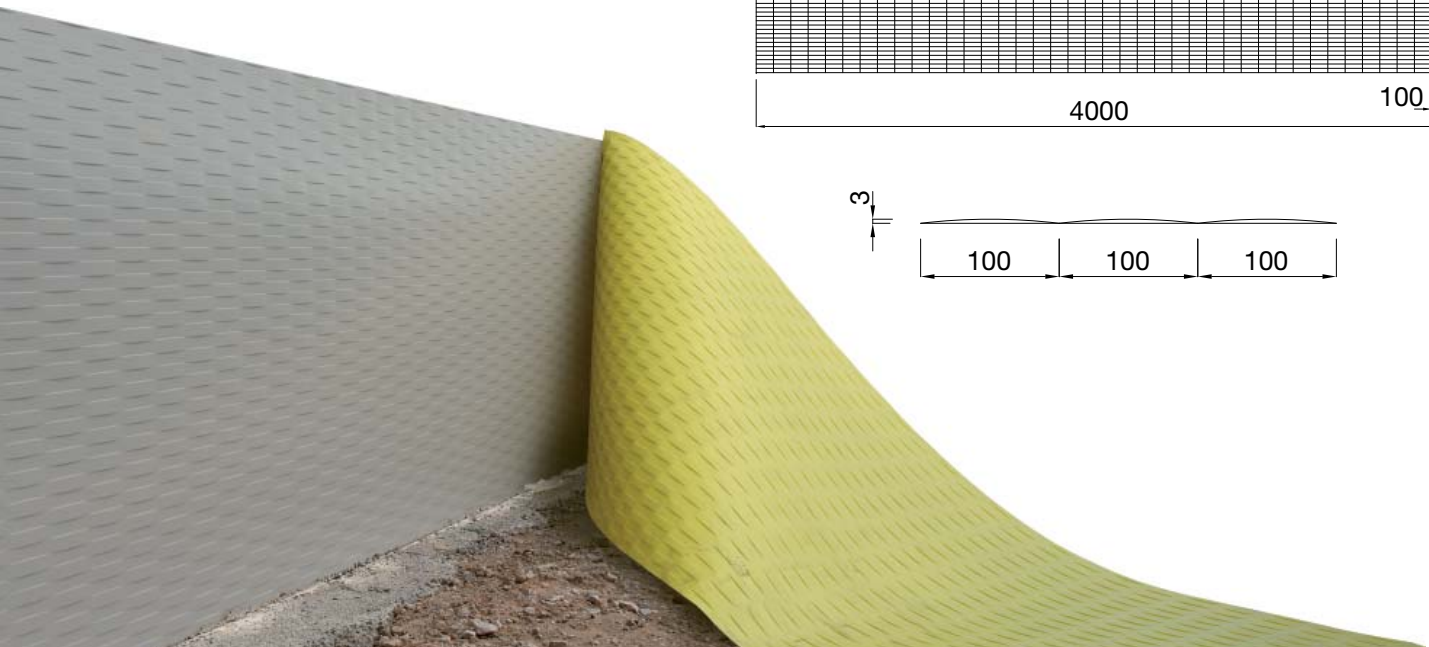

FORM COLLECTION

MOD.

030

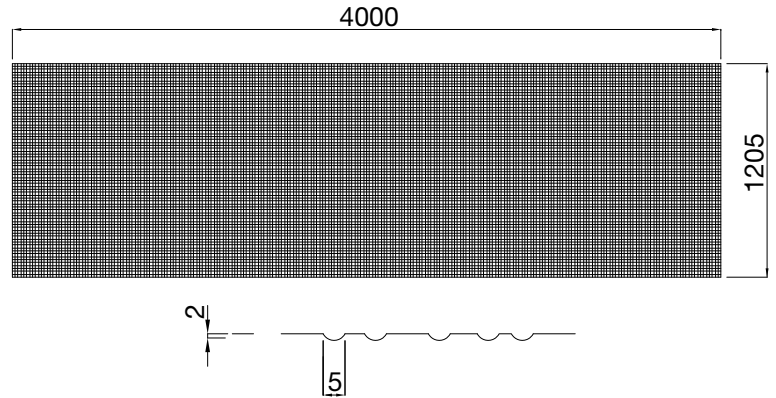

MOD.

031

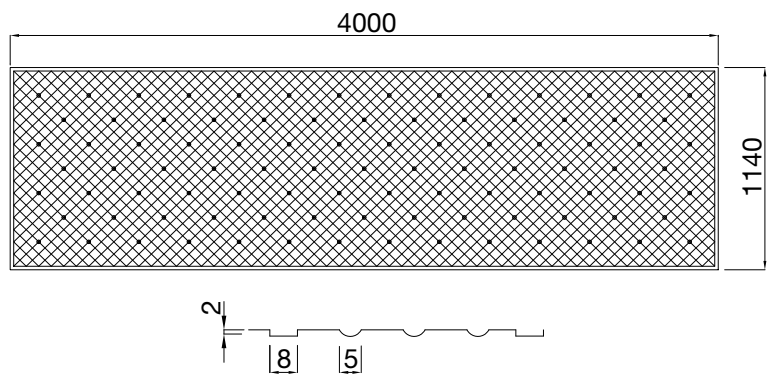
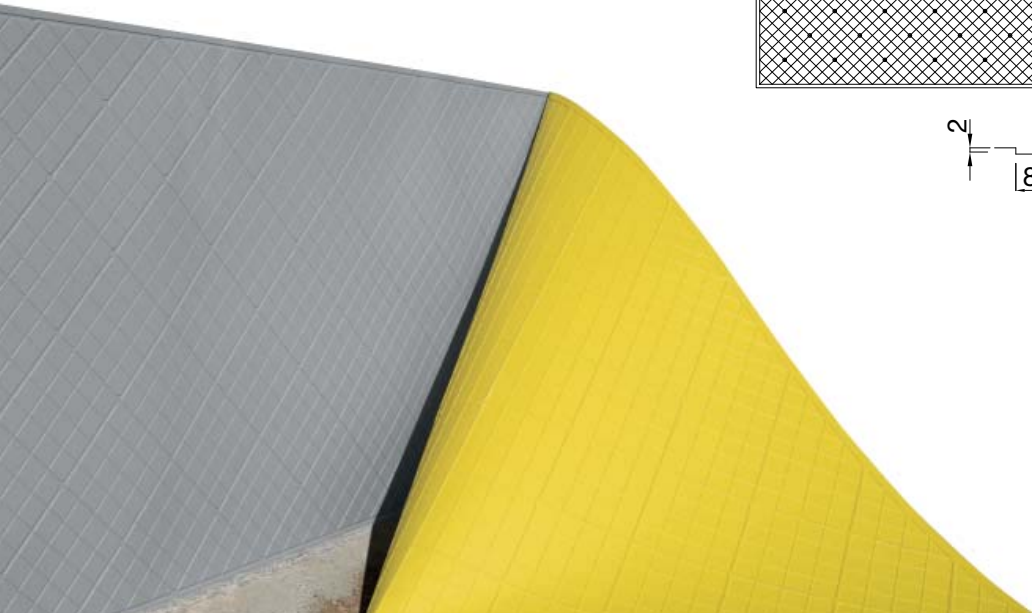

FORM COLLECTION

MOD.

032

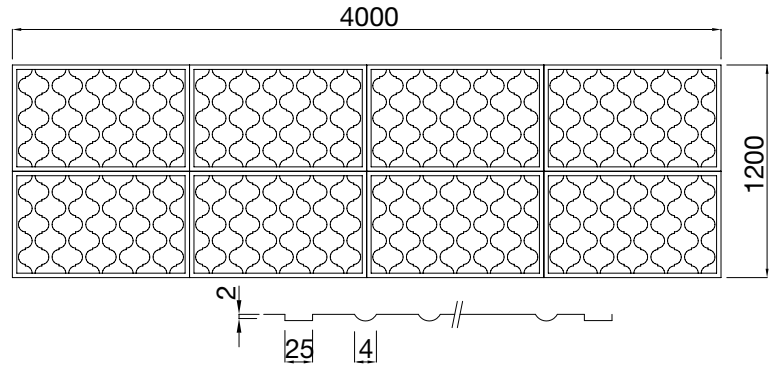

MOD.
033

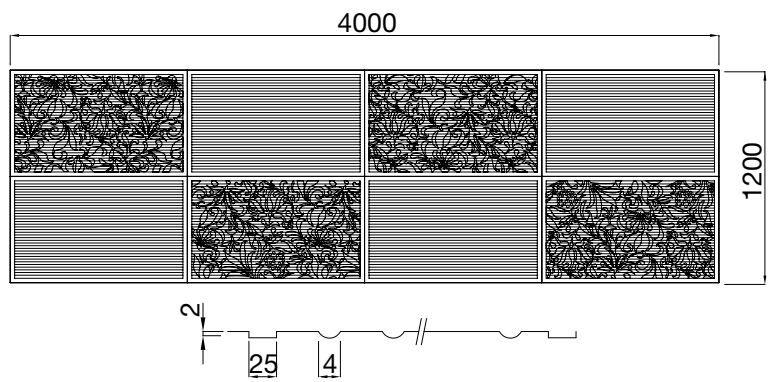
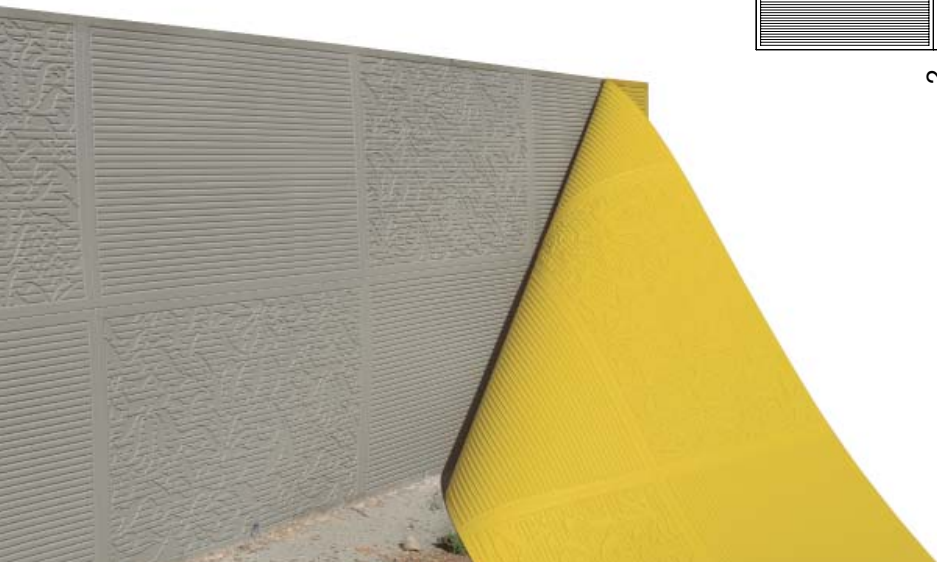

FORM COLLECTION

MOD.

061

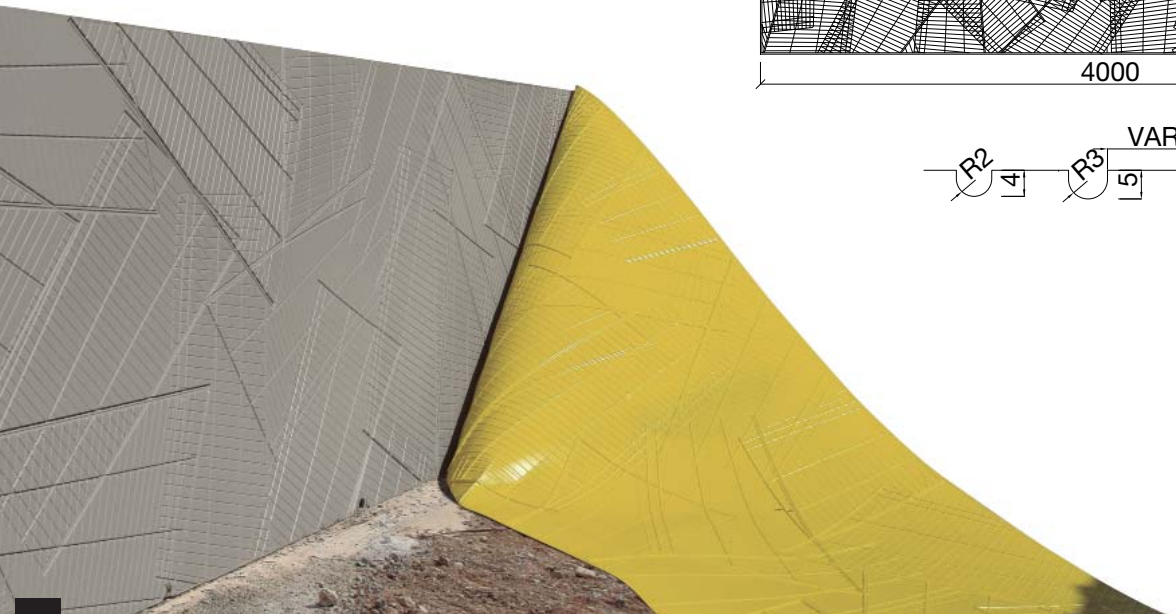
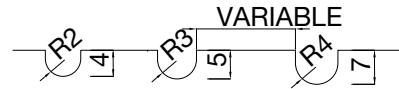
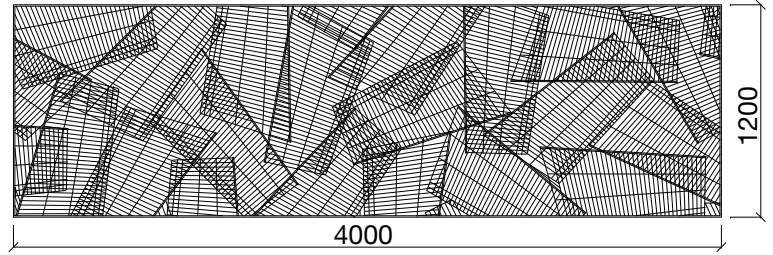

MOD.
075

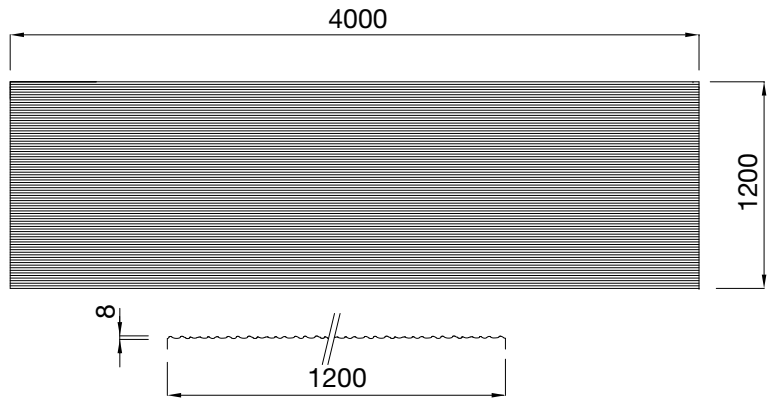
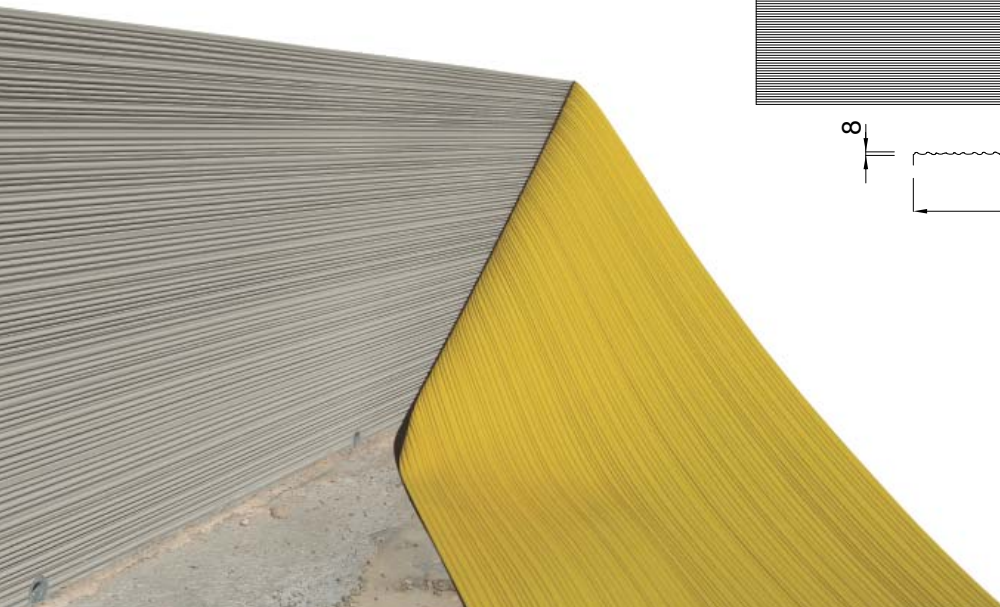

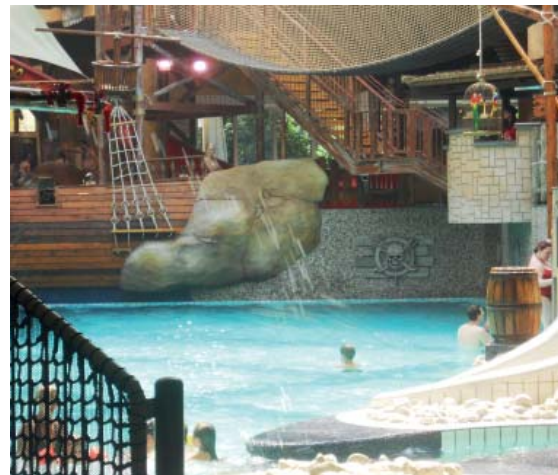



STONE COLLECTION

MOD.

051

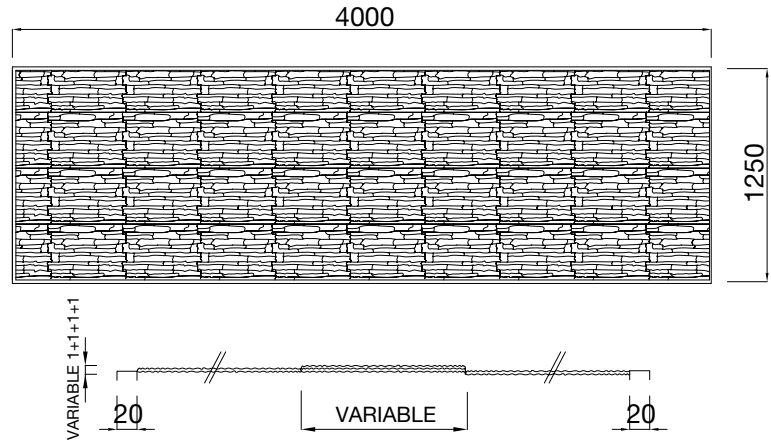
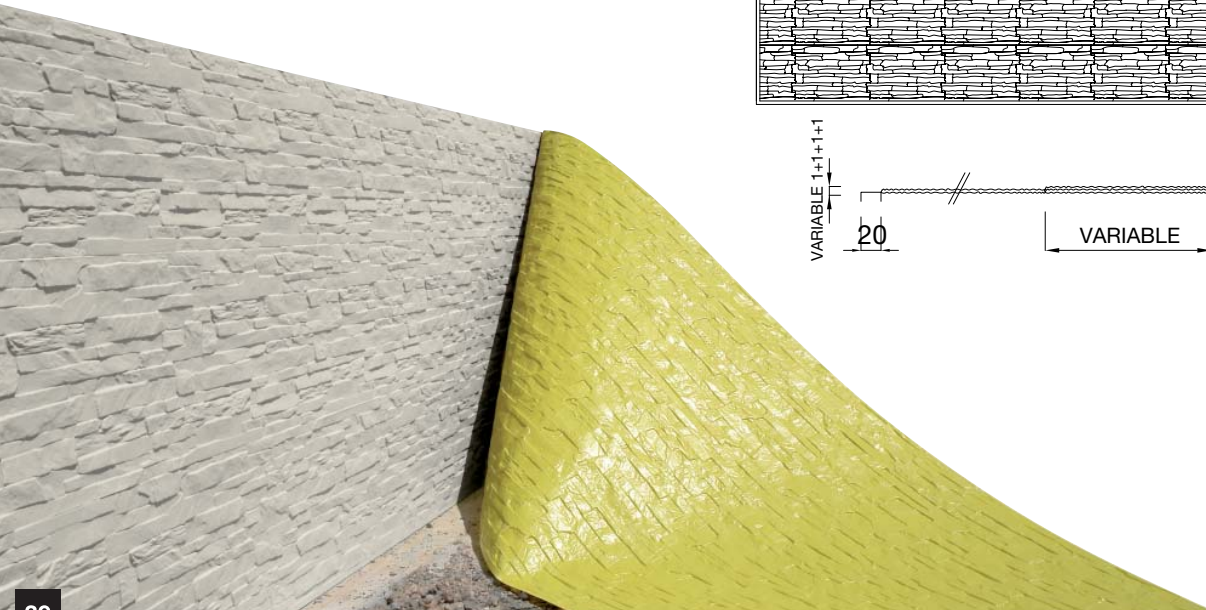

MOD.
052

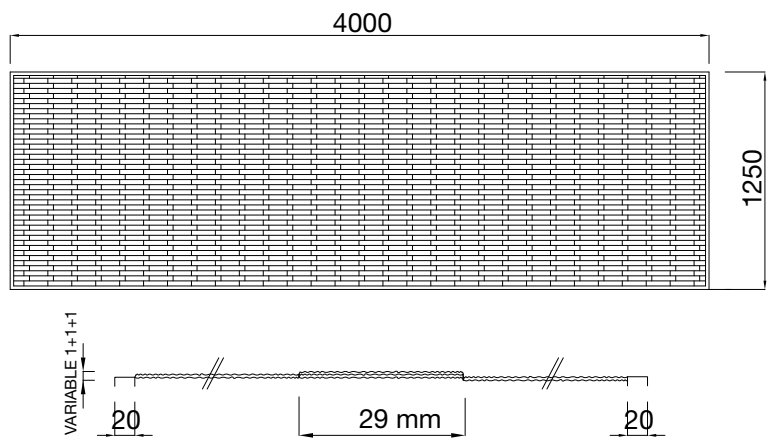
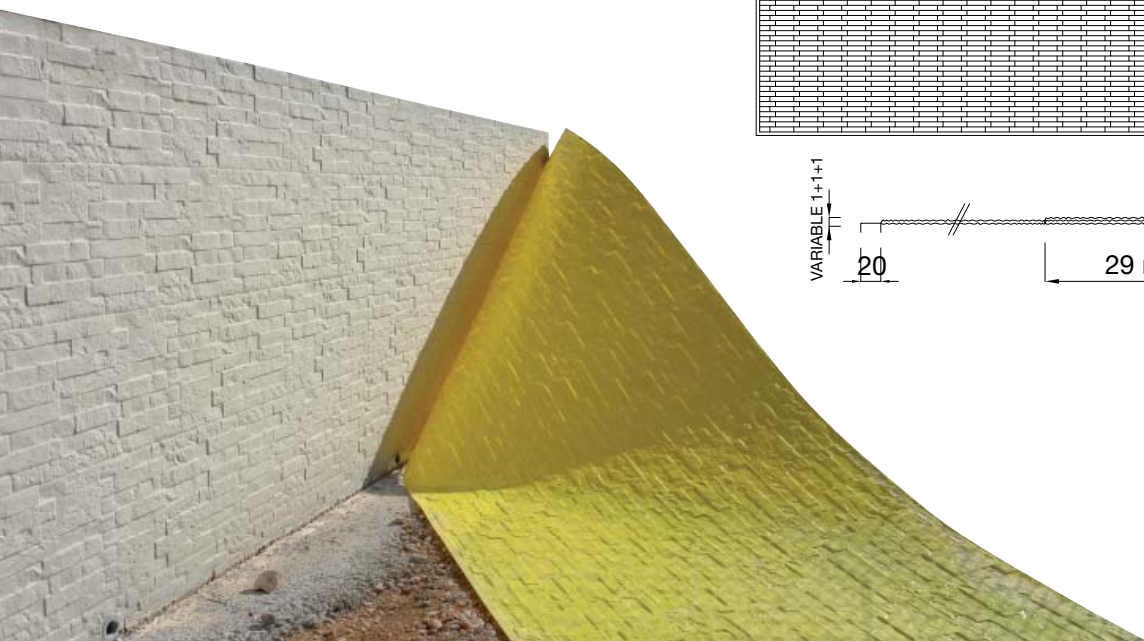

STONE COLLECTION

MOD.

053

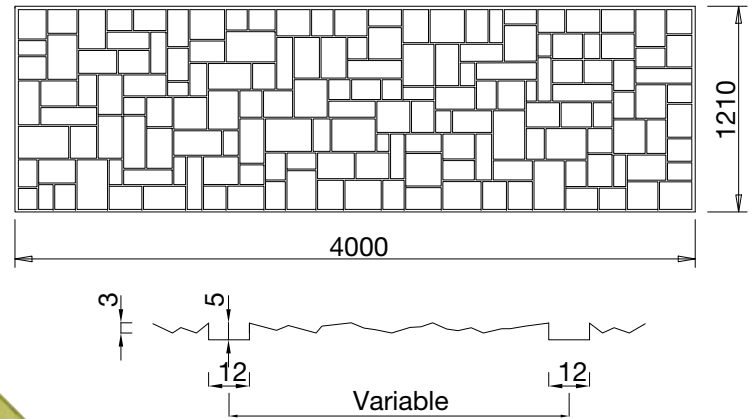
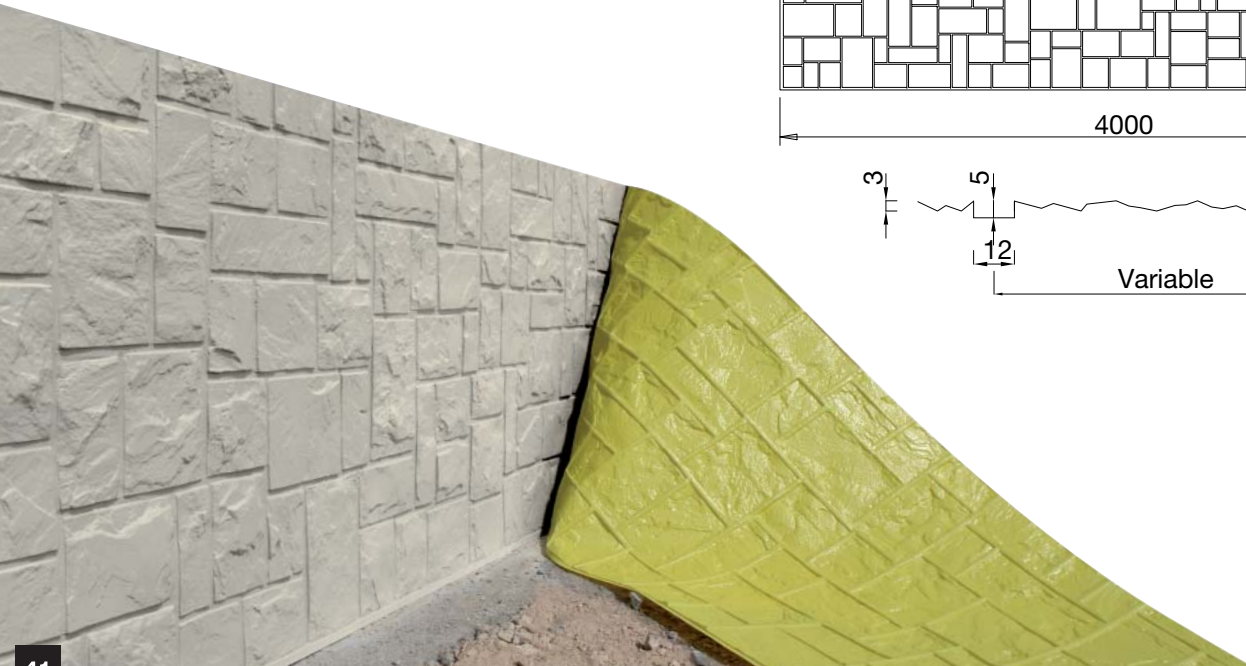

MOD.
054

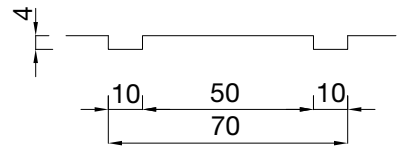
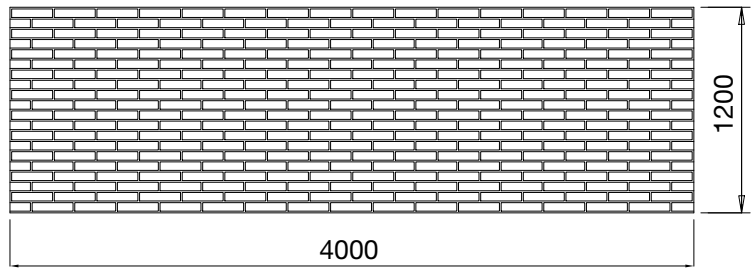
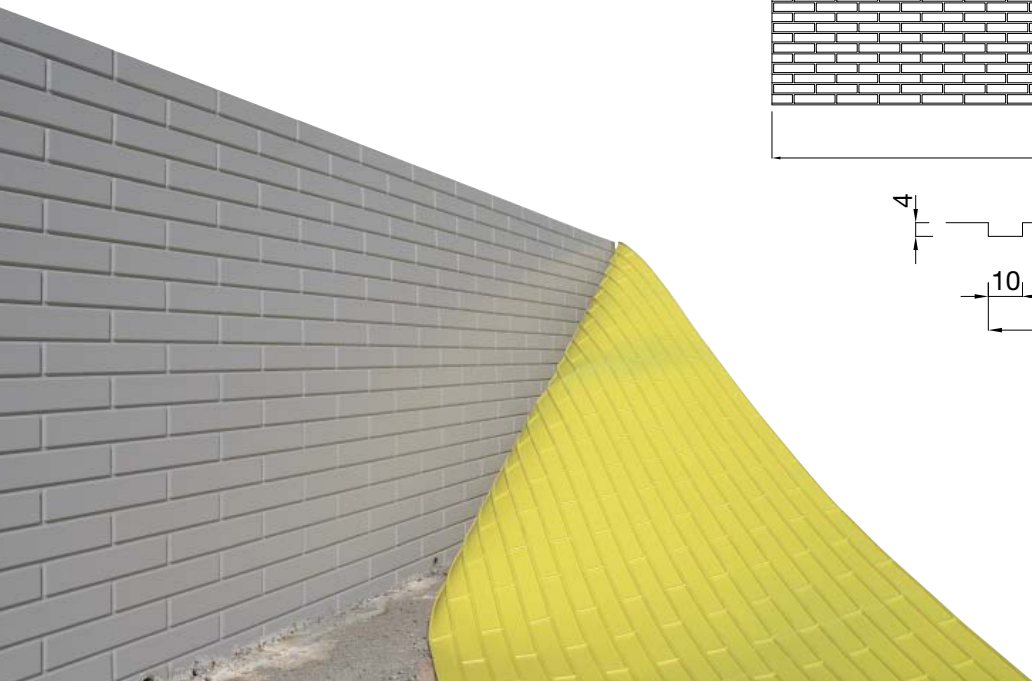

STONE COLLECTION

MOD.

055

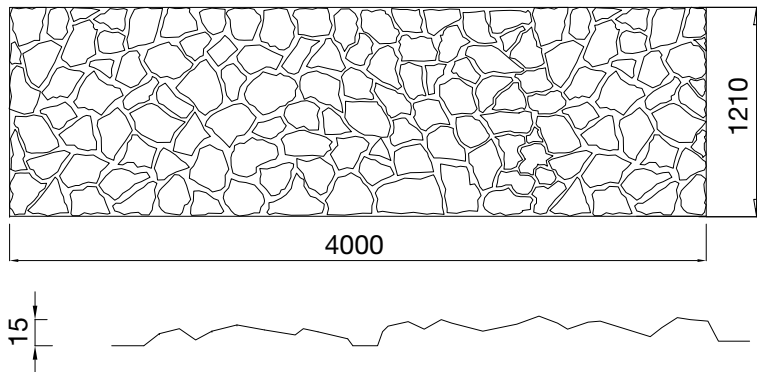
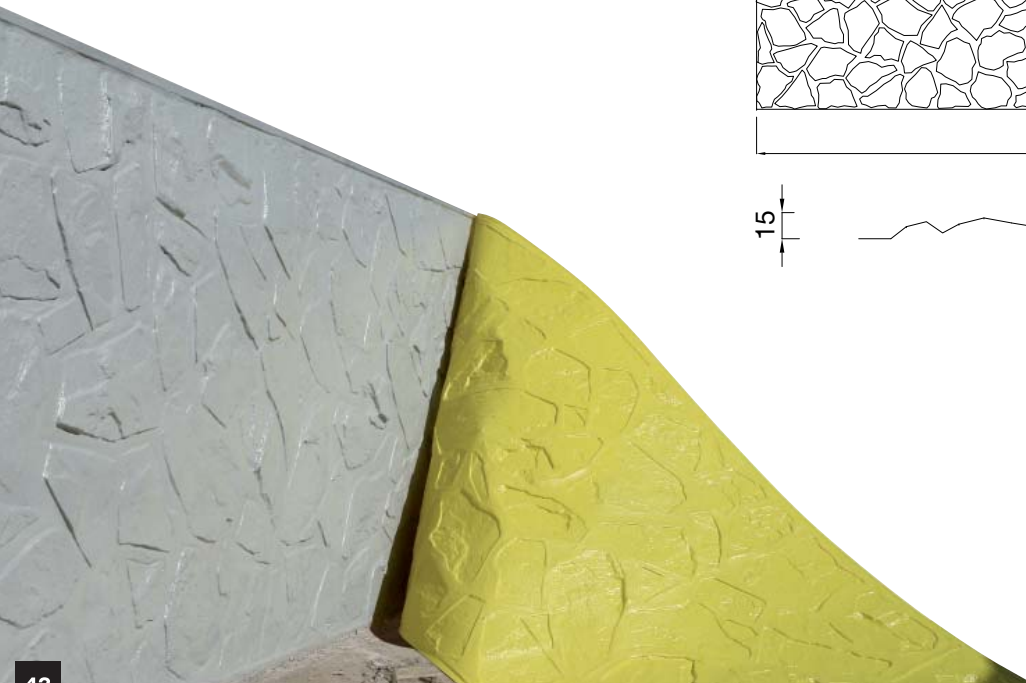

MOD.
056

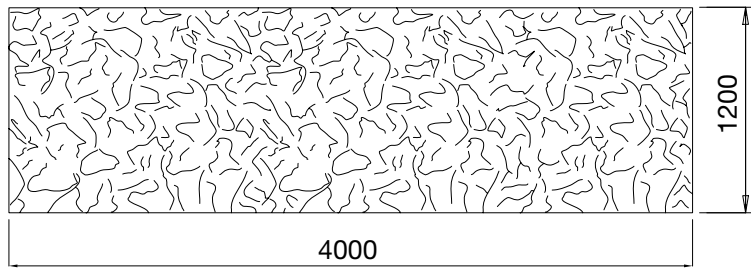
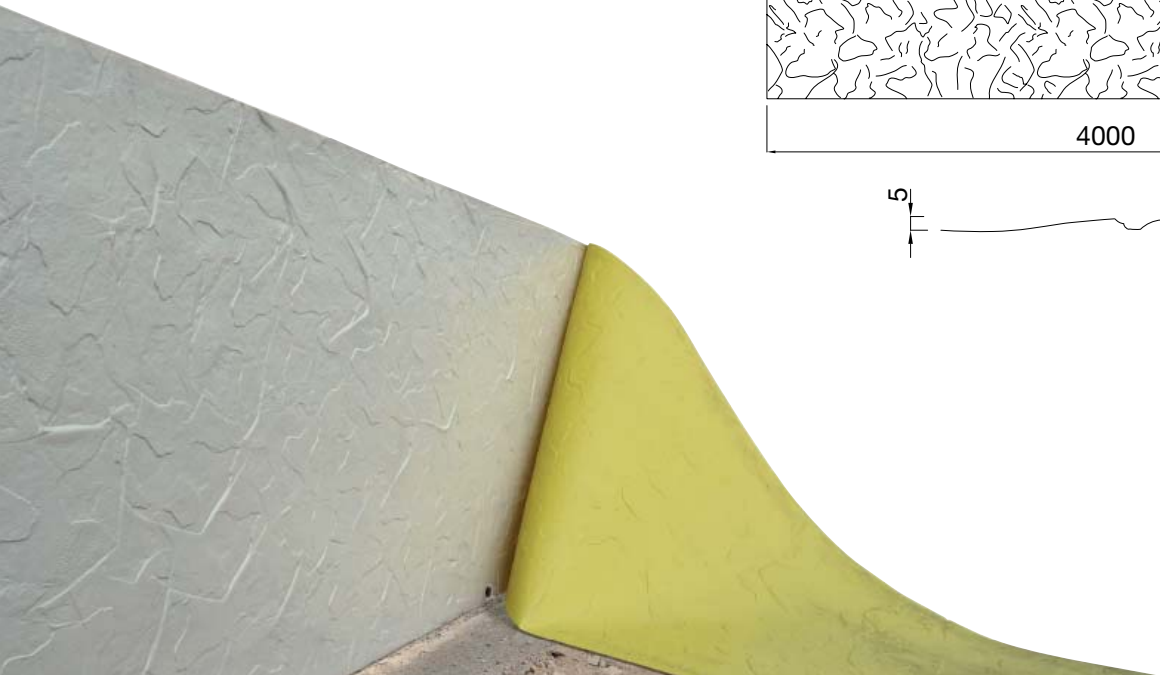

STONE COLLECTION

MOD.

057

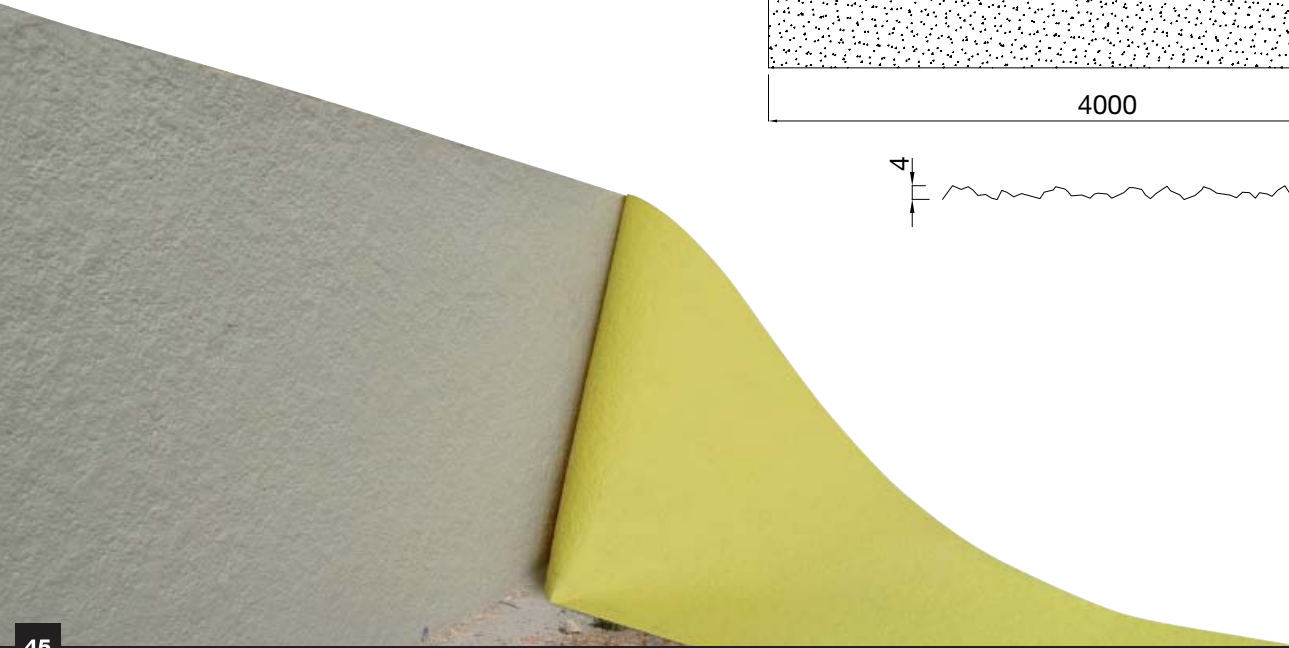
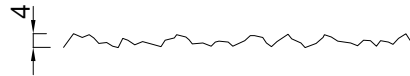
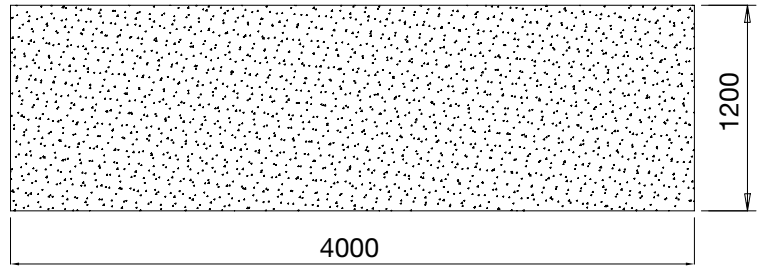

MOD.

058

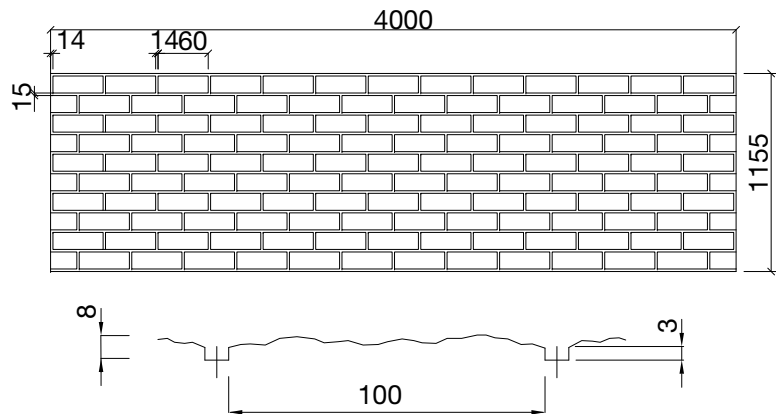
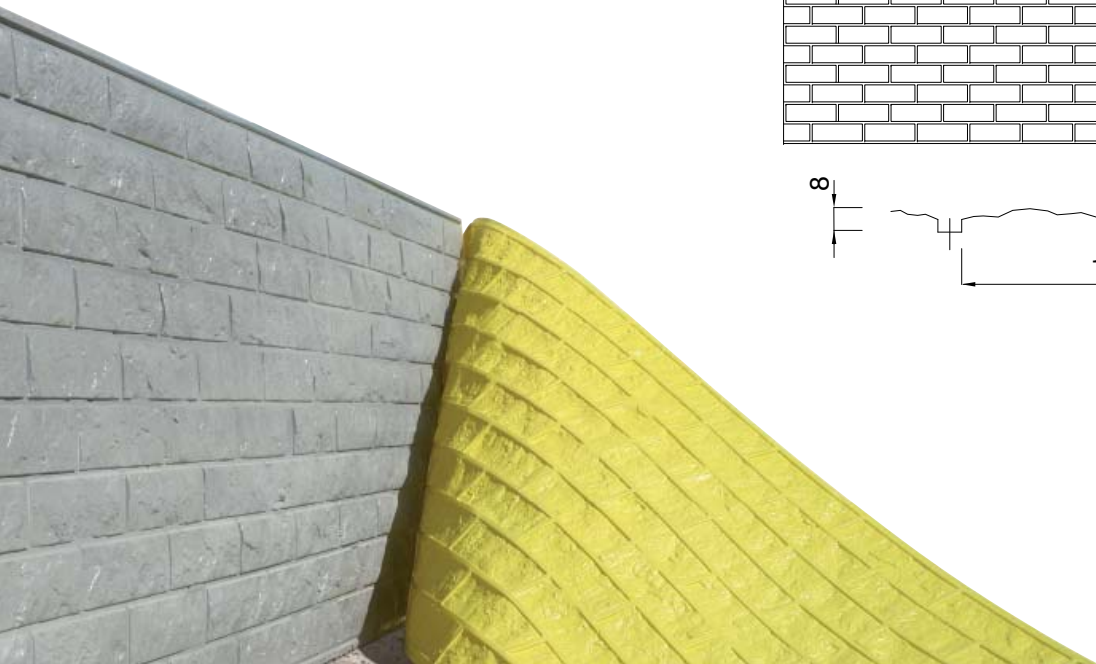

STONE COLLECTION

MOD.

059

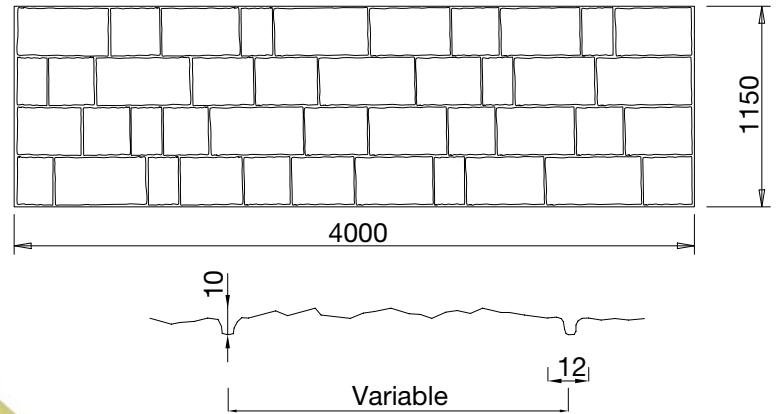
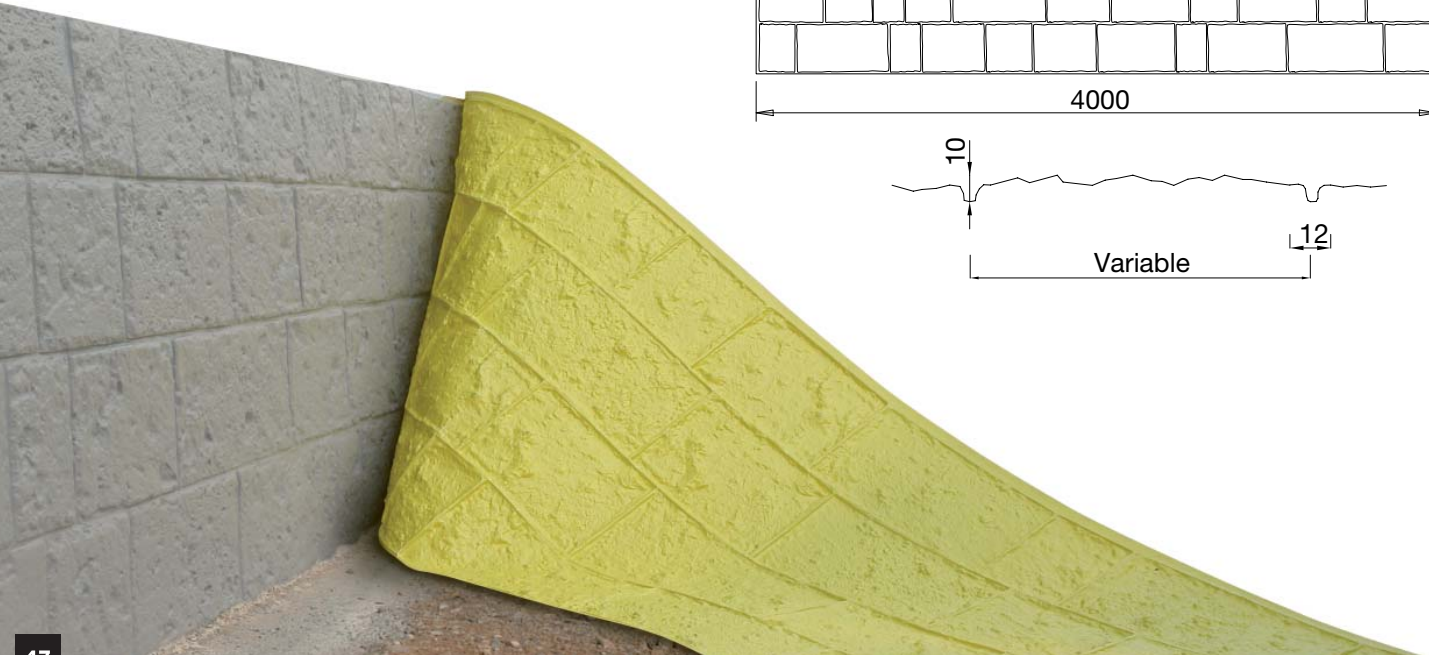

MOD.
060

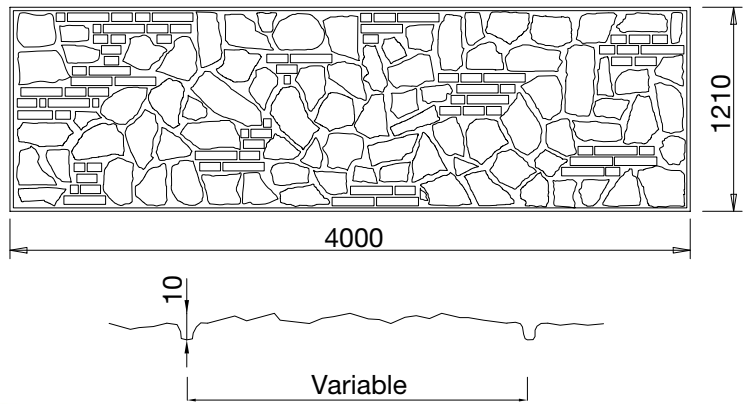

STONE COLLECTION

MOD.

070

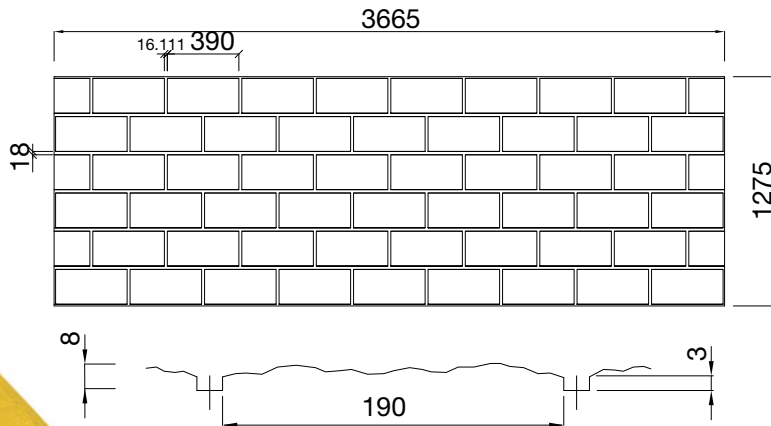

MOD.
071

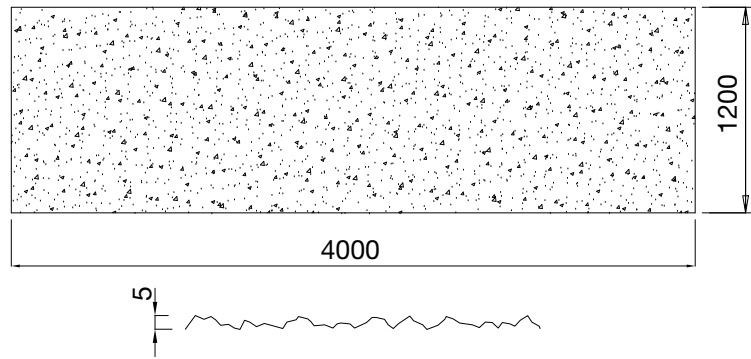
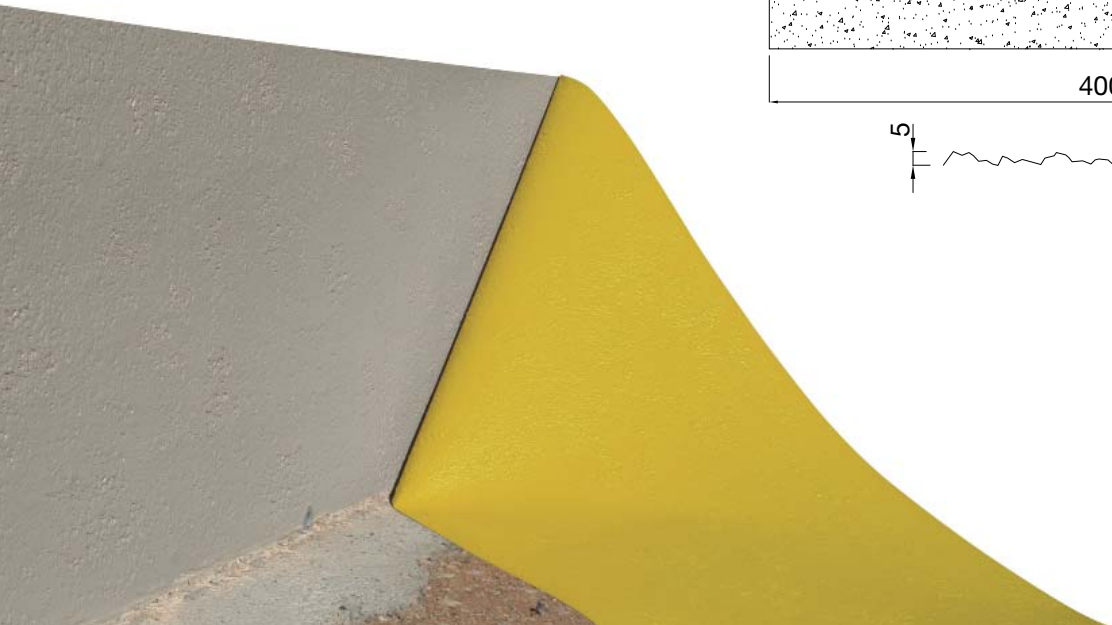

STONE COLLECTION

MOD.

076

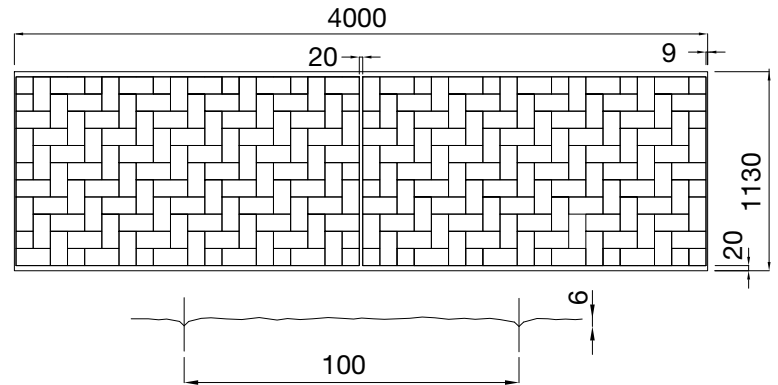



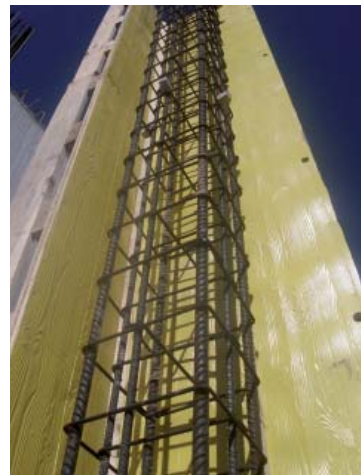

1

Spray Fijador LHV

- EN LHV Fixing Spray
- FR Spray fixateur LHV (bombe)
- DE Befestigung-Spray LHV

1



2



2

Cola Liquida LHV

- EN LHV Liquid Glue
- FR Colle liquide LHV (bidon)
- DE Flüssige-Klebstoff

3

Juntas Sellado LHV

- EN Tape for LHV joints
- FR Union des joints LHV
- DE Fugen-Abdichtung LHV

3





Tel.: 902 111 250
Fax: 902 111 251

info@grupovalero.com
www.grupovalero.com