

GINGER

Joan Gaspar, 2014



Difusor de madera prensada de 4 mm en roble natural o wengué. Disipador de aluminio inyectado y lacado en negro mate.

- Roble
- Wengué

Ginger 42

63 LED SMD 14,8W 700mA 2700K 1780lm (incluido)

Ginger 32

36 LED SMD 8,5W 700mA 2700K 1015lm (incluido)

Ginger 42

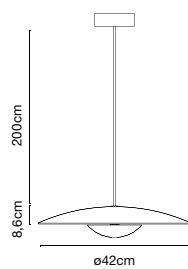

Ginger 32

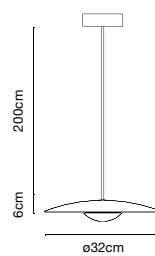

Dimmer

Colección

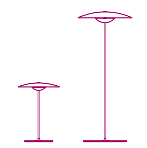

GINGER

Joan Gaspar, 2014

Ginger 32 & S (LED 2014)

36 LED SMD 9,4W 700mA 2700K 845lm

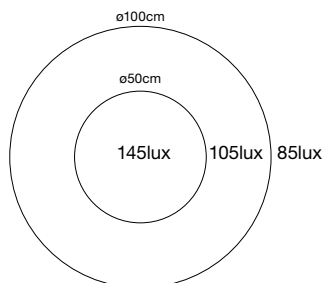

Ginger 32 & S (New LED 2015)

36 LED SMD 8,5W 700mA 2700K 1015lm

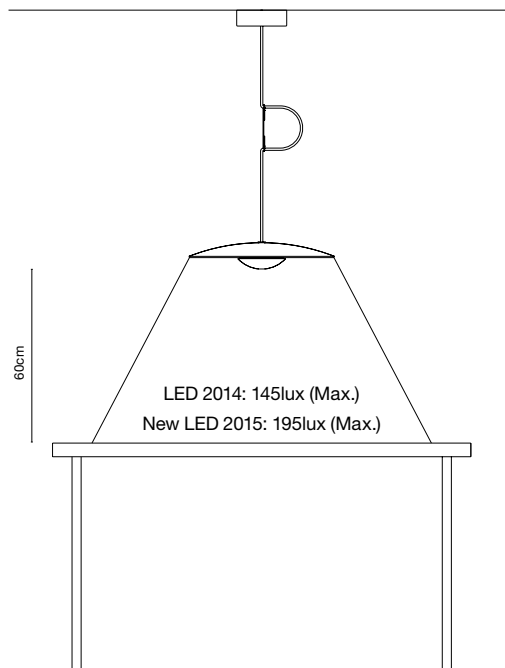
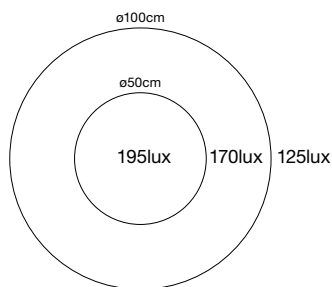

Ginger 42 & P (LED 2014)

63 LED SMD 16,2W 700mA 2700K 1480lm

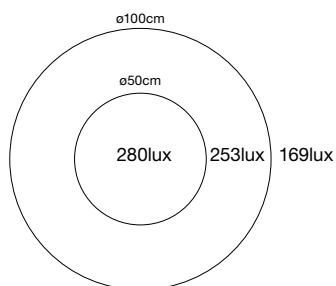

Ginger 42 & P (New LED 2015)

63 LED SMD 14,8W 700mA 2700K 1780lm

